

X-320

User's Manual

Revision 1.5

Covers Models: X-320-I



Web Enabled I/O

Digital | Analog | Frequency

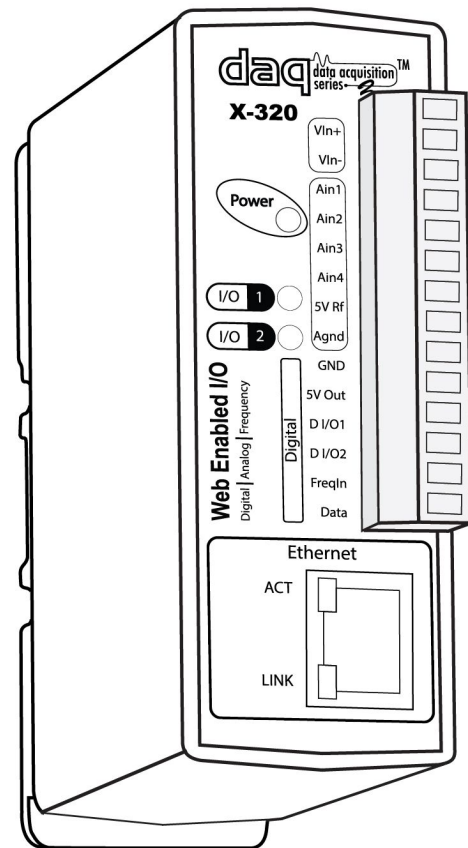

www.ControlByWeb.com

a division of....

Xytronix Research & Design, Inc.
Nibley, Utah, USA

Table of Contents

Trademark and Copyright Information.....	5
Warranty.....	6
FCC Statement.....	7
Installation Guidelines (Read Before Installing).....	8
Section 1: Introduction.....	9
1.1 X-320™ Features.....	10
1.2 Applications.....	11
1.3 X-320™ Models Available.....	12
1.3.1 Optional Accessories.....	12
1.4 Connectors & Indicators.....	13
1.5 Accessing X-320™.....	14
Section 2: Installation and Setup	15
2.1 Mounting.....	15
2.1.1 Wall Mounting.....	15
2.1.2 DIN-Rail Mounting.....	15
2.2 Connection.....	16
2.2.1 Power Supply Connection.....	17
2.2.2 Digital I/O Connection.....	17
2.2.3 Analog Input.....	19
2.2.4 Frequency Input.....	23
2.2.5 Temperature/Humidity Sensor Connection	23
2.2.6 Network Connection.....	25
2.3 Establishing Communications for Setup.....	27
2.3.1 Method 1: Assign a Temporary IP address to X-320™	27
2.3.2 Method 2: Assign a Temporary IP Address to Configuration Computer	29
2.4 X-320™ Setup Pages	32
2.4.1 Main Tab.....	32
2.4.2 Network Tab.....	34
2.4.3 Advanced Network Tab.....	38
2.4.4 Password Tab.....	42
2.4.5 Date/Time Tab	44
2.4.6 Logging Tab.....	48
2.4.7 Digital I/O Tab.....	51
2.4.8 Frequency Input Tab.....	60
2.4.9 Analog Tab.....	65
2.4.10 Sensor Tab.....	77
2.4.11 Remote Relays Tab.....	81
2.4.12 Events Scheduler Tab.....	83
2.4.13 Script Tab	88
2.4.14 Control Page Setup Tab.....	91
Section 3: Operation.....	93
3.1 Browser Operation.....	93

3.2 XML Operation.....	96
3.2.1 state.XML.....	96
3.2.2 eventX.XML.....	99
3.2.3 Diagnostics.XML.....	100
3.3 GET Requests.....	101
3.3.1 Using GET for Control and Monitoring.....	101
3.3.2 http (GET) Event Configuration.....	101
3.3.3 Common Base Ten Values for Event Days.....	102
3.4 Modbus Operation.....	103
3.4.1 X-320™ Function Code Summary.....	103
3.4.2 PLC Device Addressing.....	104
3.4.3 X-320™ Full Address Table.....	105
3.4.4 Read Coils - Modbus Function Code 01 (0x01).....	106
3.4.5 Read Discrete Inputs – Modbus Function Code 02 (0x02).....	107
3.4.6 Read Sensors – Modbus Function Code 03 (0x03)	108
3.4.7 Write Single Coil – Modbus Function Code 05 (0x05).....	110
3.4.8 Write Multiple Coils - Modbus Function Code 15 (0x0F).....	111
3.4.9 Write Multiple Registers – Modbus Function Code 16 (0x10).....	112
3.5 Email Notification.....	113
3.5.1 Email Notification Description.....	113
3.5.2 Email Notification Setup	114
Appendix A: Restoring Factory Default Settings.....	115
Appendix B: Installing New Firmware.....	116
Requirements	
Setup	
Device Upgrade Procedure	
Appendix C: Accessing X-320™ Over the Internet.....	118
IP Addresses	
A Simple Local Area Network	
A Simple LAN connected to the Internet	
Port Forwarding	
Accessing Setup Pages	
Appendix D: Log Files	122
Data Log File – log.txt	
System Log File – syslog.txt	
Appendix E: External Server and Remote Services.....	124
Accessing X-320™ with Custom Software or Third Party Applications	
Using an External Web Server	
Direct Server Control	
Remote Services	
Connection String	
Appendix F: SNMP Requests, Objects and Community Strings.....	126
Standard Objects	
Xytronix Objects	
Password	
Appendix G: BASIC Scripts.....	130

Structure
Supported Statements
User-Defined Variables
Predefined Variables
External Variables
Testing and Debugging

Appendix H: Modbus Details..... 138

- Read Coils - Modbus Function Code 01 (0x01)
- Read Discrete Inputs – Modbus Function Code 02 (0x02)
- Read Sensors – Modbus Function Code 03 (0x03)
- Write Single Coil – Modbus Function Code 05 (0x05)
- Write Multiple Coils - Modbus Function Code 15 (0x0F)
- Write Multiple Registers – Modbus Function Code 16 (0x10)

Appendix I: Specifications..... 152

Appendix J: Mechanical Information..... 155

Trademark and Copyright Information

This document is Copyright ©2011-2018 by Xytronix Research & Design, Inc. All rights reserved.

X-320™, WebRelay™, ControlByWeb™, and Xytronix Research & Design™ are trademarks of Xytronix Research & Design™, Inc. 2005-2018.

All other trademarks are the property of their respective owners.

All parts of this product and design including but not limited to firmware, hardware design, schematics, PCB layout, concept, graphics, users manual, etc., are property of Xytronix Research & Design, Inc. ©2005-2018. X-320™ may not be opened, disassembled, copied or reverse-engineered.

No part of this manual may be reproduced or transmitted in any form or by any means, electronic or mechanical, including photocopying or scanning, for any purpose other than the personal use by the purchaser of this product. Xytronix Research & Design, Inc., assumes no responsibility for any errors that may appear in this document.

Whereas reasonable effort has been made to make the information in this document as useful and accurate as possible, Xytronix Research & Design, Inc. assumes no responsibility for the application, usefulness, or completeness of the information contained herein. Under no circumstance will Xytronix Research & Design, Inc. be responsible or liable for any damages or losses including direct, indirect, special, incidental, or consequential damages or losses arising from either the use of any information contained within this manual or the use of any products or services referenced in this manual.

Xytronix Research & Design, Inc. reserves the right to change any product's features, specifications, documentation, warranties, fee schedules, and conditions at any time and without notice.

Warranty

This Xytronix Research & Design, Inc. product has a warranty against defects in material and workmanship for a period of one year from the date of shipment. During the warranty period, Xytronix Research & Design, Inc. will, at its option, either repair or replace products that prove to be defective. This warranty is extended to the original purchaser of the equipment only.

For warranty service or repair, the product must be properly packaged, and returned to Xytronix Research & Design, Inc. The purchaser shall prepay all charges for shipping to Xytronix Research & Design, Inc., and Xytronix Research & Design, Inc. will pay the shipping charges to return the product to the purchaser as long as the product is shipped within the United States. If the product is shipped outside of the United States, the purchaser shall pay all shipping charges, duties, and taxes.

Limitation

The foregoing warranty shall not apply to defects or damage resulting from improper use or misuse, unauthorized repair, tampering, modification, improper connection, or operation outside the electrical/environmental specifications for the product. Further, the warranty does not cover Acts of God, such as fire, flood, hurricanes, and tornadoes. This warranty does not cover damage to property, equipment, direct, indirect, consequential, or incidental damage (including damage for loss of business profit, business interruption, loss of data, and the like) arising out of the use or misuse of this product.

UNDER NO CIRCUMSTANCES WILL THE LIABILITY OF XYTRONIX RESEARCH & DESIGN, INC. TO THE PURCHASER OR ANY OTHER PARTY EXCEED THE ORIGINAL PURCHASE PRICE OF THE PRODUCT, REGARDLESS OF THE FORM OF THE CLAIM. No other warranty is expressed or implied. Xytronix Research & Design, Inc. specifically disclaims the implied warranties or merchantability and fitness for a particular purpose. Some jurisdictions may not allow the exclusion of limitation of liability for consequential or incidental damage.

FCC Statement

This device complies with Part 15 of the FCC Rules. Operation is subject to the following two conditions:

- This device may not cause harmful interference.
- This device must accept any interference received, including interference that may cause undesired operation.

Warning

This equipment has been tested and found to comply with the limits for a Class B digital device, pursuant to Part 15 of the FCC Rules. These limits are designed to provide reasonable protection. This equipment generates, uses and can radiate radio frequency energy and, if not installed and used in accordance with the instructions, may cause interference to radio communications. There is no guarantee, however, that interference will not occur in a particular installation. If this equipment does cause harmful interference to radio or television reception, which can be determined by turning the equipment off and on, the user is encouraged to try to correct the interference by one or more of the following measures:

- Reorient or relocate the receiving antenna.
- Increase the separation between the equipment and receiver.
- Connect the equipment into a relay on a circuit different from where the receiver is connected.
- Consult the dealer or an experienced radio/TV technician for help.

Notice

Changes or modification not expressly approved by the party responsible for compliance could void the user's authority to operate the equipment.

Installation Guidelines (Read Before Installing)

- This unit must be installed by qualified personnel.
- This unit must not be installed directly outdoors.
- This unit must not be used for medical, life saving purposes, or for any purpose where its failure could cause serious injury or the loss of life.
- This unit must not be used in any way where its function or failure could cause significant loss or property damage.

Security Notes

X-320™ does not employ a general purpose computer operating system and does not have features, such as telnet, FTP, SSH, nor uncontrolled open ports. This means it is unlikely for someone to 'break in' to X-320™ and access other devices on your local network. The simplicity of X-320™ makes it a inherently secure device. Nevertheless, as with any device installed on a network, appropriate security precautions should be observed.

If X-320™ is installed on the Internet, it is recommended that passwords be enabled for the **Control Page**. Passwords should be at least 8 characters in length and use a combination of upper and lower case letters and numbers. For additional security, a firewall may be used to limit access to selected IP addresses. Another option may be to set up a Virtual Private Network (VPN) between the network where X-320™ resides and the client machine (web browser, another, ControlByWeb™ product, etc.).

Final Installation Notes

This ControlByWeb™ product supports connection to *10 Mbps* and *100 Mbps* networks. Although *100 Mbps* networks are faster, the amount of data transferred to and from this device is very minimal and little, if any, performance increase will be gained by setting it to *100 Mbps*. There are advantages, however, to operate this device at *10 Mbps*. At *10 Mbps*, less power is required, the unit runs cooler, and the lifetime of the product will be extended.

Any changes to the Ethernet settings will require a removing and re-applying power to X-320™.

Section 1: Introduction

X-320™ is a multi-function industrial control and instrumentation module, combining many of the features found on other ControlByWeb products and adding new capabilities to the product line. X-320™ includes programmable Digital I/O with programmable pull resistors, pulse counters, and pulse rate is introduced. X-320™ also adds a dedicated frequency input (130 kHz max).

Other great features of ControlByWeb products are also included, such as remote relays, 24-bit analog input, email notification, BASIC scripting, scheduling, digital temperature, and digital humidity sensor inputs.

As with other ControlByWeb products, it supports a number of Ethernet protocols with it's built-in server, including HTTP, Modbus/TCP, SNMP, NTP, and XML.

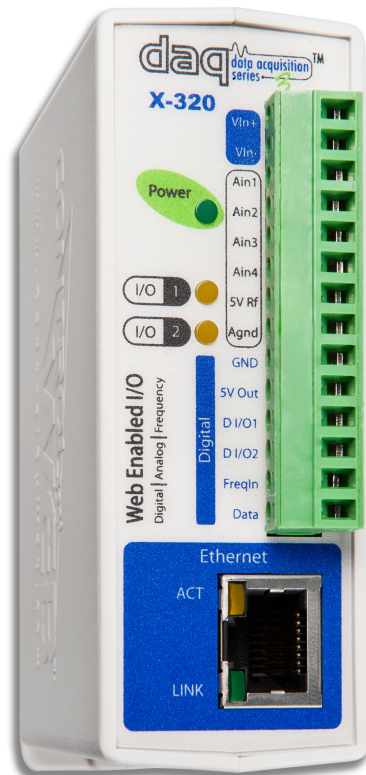

Figure 1.1 - Product Image

1.1 X-320™ Features

Frequency Input (1)

130 kHz maximum input, 0-5 V.

Monitor equipment operation, flow meters, audio signals, anemometers, pressure, and more.

Analog Input (4)

24-bit analog measurements from 0-5 VDC, configurable as single-ended or differential inputs.

Use with AC current probes, wind vanes, pyranometers, pressure transducers, and much more.

Also, configurable as digital inputs with programmable switching thresholds.

Digital I/O (2)

Programmable as outputs or inputs.

Programmable pull-up and pull-down resistors on inputs.

Pulse counter.

Pulse rate, 25 Hz max

Remote Relays (3)

Control relays on other ControlByWeb products based on input conditions.

Temperature or Humidity Digital Sensor Inputs (6)

Monitor any combination of temperature or humidity sensors up to 600 ft away.

Real-time Clock

Manual or NTP capability.

Event Scheduler

Program up to 50 control events based on time and date conditions.

Automatically switch from weekday to weekend or holiday schedules.

Logging

Configurable logging of any inputs, including temperature, humidity, analog values, I/O states, and frequency.

System logging of device operating parameters and events, such as power reset and NTP requests.

Email Notification

Send email alerts based on any sensor or input conditions, such as temperature, time, frequency, digital inputs, analog voltage levels, and more.

Send text messages to cell phone through wireless carriers email bridge.

BASIC Script

Additional flexibility is provided through custom scripts using an easy-to-learn BASIC interface.

Web Server and Protocols

All configurable through the built-in, password protected web server. Additional interface options include XML, Modbus/TCP, and SNMP. Static or DHCP IP address configuration.

1.2 Applications

X-320™ was designed to meet a broad range of industrial and scientific applications including:

Environmental Monitor

The general purpose interface of X-320™ is similar to other ControlByWeb products. The standard web interface allows X-320™ to be used for applications which require a broader range of instruments including anemometers, wind vanes, temperature sensors, flow meters, pyranometers, and more.

The built-in control capability of X-320™ can be leveraged to operate alarms or provide input to irrigation or security systems.

Since the X-320™ can operate without being connected to a PC or server, it can be configured to operate equipment and controls in remote locations based on event schedules or inputs, such as wind speed, water level, temperature, frequency, pulse counter rate, or pressure.

Advanced users with multiple X-320's can aggregate data under a common server application using the XML or SNMP services.

Process Controller

X-320™ may be suitable for process control applications where a PLC may be used or to augment PLC capabilities. Not only is X-320™ more economical than a PLC, the ease of programming reduces deployment and configuration maintenance costs.

The Modbus/TCP interface can be used to monitor or control X-320™ features. The customizable control page interface and flexibility of the inputs, allows the X-320™ to be adapted to applications that require flow, level, pressure, temperature, switch input, and discrete output capability.

Process Monitor

Critical processes may require control redundancy or independent monitoring. The password-protected configuration and control pages ensure that unauthorized changes are not made. The control page features can be customized to provide only monitoring information. The HTML interface allows management oversight without the need to install or purchase proprietary software.

Email, SNMP, XML, and Modbus/TCP alerts can be generated automatically when process parameters limits are violated or interrupted.

1.3 X-320™ Models Available

X-320™ is currently available in 2 models. The main differences between each model are listed below.

X-320	X-320 with 9-28 VDC input and general purpose Control Page.
X-320M	X-320 with 9-28 VDC input and weather station Control Page.

1.3.1 Optional Accessories

Accessory	Description	Part Number
Temperature Sensor	Digital temperature sensor with 12 inch wire leads. Note: Leads may be extended	X-DTS-U
Temperature Sensor (Wall Mount)	Digital temperature sensor housed in vented plastic enclosure	X-DTS-WM
Temperature/Humidity Sensor (Wall Mount)	Digital temperature and humidity sensor housed in vented plastic enclosure.	X-DTHS-WM

1.4 Connectors & Indicators

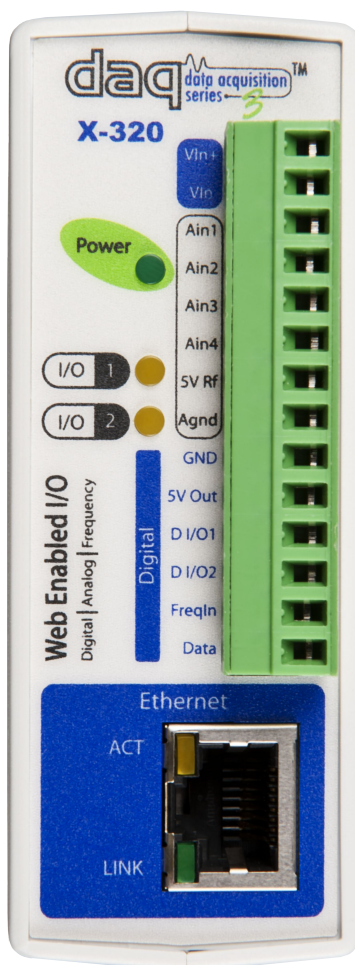

Figure 1.4a - Connections & Indicators

I/O Connector

X-320™ has a 14-position removable terminal connector and an Ethernet connector. The terminal connector is used to provide power to the module and connect Digital I/O, Analog Inputs, Frequency Input, and Temperature/Humidity Sensor Inputs.

Network Connector

The Ethernet connector is a standard, 8-position modular receptacle.

Module Power Indicator

The green Power LED indicator is illuminated whenever the module is powered.

I/O Indicators

Two green LEDs illuminate when the corresponding Input or Output is active.

Ethernet Indicators

The LINK LED is illuminated green when the module is properly connected to an Ethernet network and is ready to communicate. Network communications will only occur if this LED is illuminated. The ACT LED flashes amber when activity is detected on the network.

1.5 Accessing X-320™

Standard Access Using a Web Browser

X-320™ has a built-in web server that provides simple web pages that can be accessed directly using a standard web browser. This allows users to access the unit with NO SPECIAL SOFTWARE installed on their computer. This is ideal for applications that require a quick, simple solution that does not need to be accessible to more than a few people. This configuration is simple to setup, simple to use, and can be accessed from any computer.

*Note: Network routers may need to be configured to allow access from computers outside of the local network (see **Appendix C: Accessing X-320™ Over The Internet**).*

Section 2: Installation and Setup

Installation consists of mounting X-320™, connecting it to an Ethernet network, providing power, configuring via a web browser, and wiring the Digital I/O's, Analog Inputs, Frequency Inputs, and Temperature and/or Humidity Sensors.

2.1 Mounting

X-320™ can be mounted to a standard (35mm by 7.55mm) DIN-Rail. Or it can be wall mounted. It should be mounted in a clean, dry location where it is protected from the elements. Ventilation is recommend for installations where ambient air temperatures are expected to be high

See **Appendix J: Mechanical Information** for additional mechanical details.

2.1.1 Wall Mounting

Mount the X-320™ to a wall by using two #8 screws. Attach the screws to the wall vertically spaced exactly 2.5 inches apart. The head of the screw should be about 1/10 inch away from the wall.

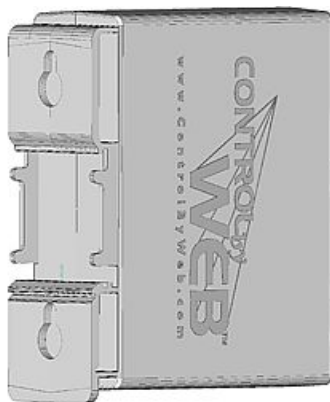

2.1.2 DIN-Rail Mounting

Attach the X-320™ to the DIN-Rail by hooking the top hook on the back of the enclosure to the DIN-Rail and then snap the bottom hook into place. To remove the X-320™ from the DIN-Rail, use a flat-head screwdriver. Insert the screw driver into the notch in the release tab and pry against the enclosure to release the bottom hook.

2.2 Connection

CAUTION: MAKE SURE POWER IS SHUT OFF BEFORE WIRING!

CAUTION: THIS UNIT SHOULD BE INSTALLED BY A QUALIFIED TECHNICIAN.

MIS-WIRING OR MIS-CONFIGURATION COULD CAUSE PERMANENT DAMAGE TO THE X-320™, THE EQUIPMENT TO WHICH IT IS CONNECTED, OR BOTH.

A removable terminal connector is provided for simple wiring. The correct wiring procedure is as follows:

1. Make sure power is turned off.
2. Remove the terminal connector from the X-320™ and make wiring connections to the terminals.
3. Reconnect the terminal connector.
4. Apply power.

It is recommended that the load (device to be controlled) not be connected to the X-320™ until after the X-320™ has been configured and tested. By doing this, wiring and configuration mistakes will not cause the load device to turn on unexpectedly.

IMPORTANT: MAKE SURE WIRES ARE PROPERLY ATTACHED TO THE TERMINALS AND THAT THE TERMINALS ARE TIGHT!

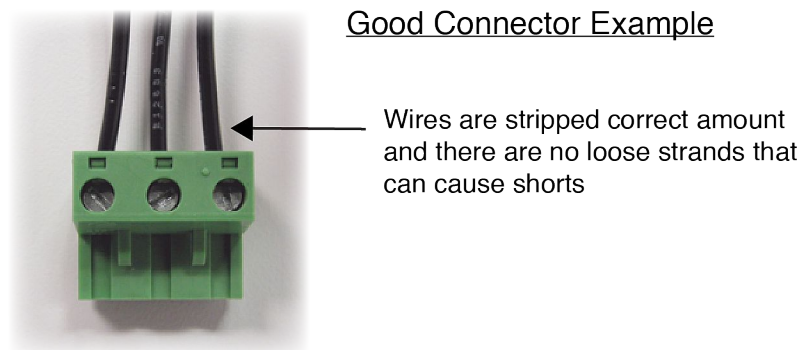
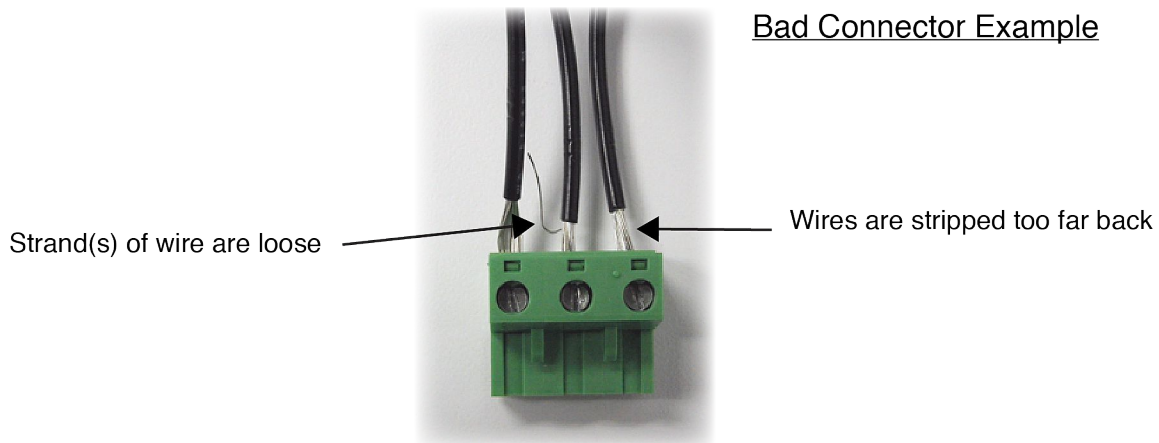

14-pin Connector Pinout	
Pin	Description
Vin+	Power Supply VDC+ 9-28 VDC for model X-320-I 5 VDC for model X-320-POE DO NOT EXCEED MAXIMUM POWER SUPPLY VOLTAGE.
Vin-	VDC- (Ground) power supply input.
Ain1	Analog Input 1+ (Single-ended mode) or Analog input 1+ (Differential mode).
Ain2	Analog Input 2+ (Single-ended mode) or Analog Input 1- (Differential mode)
Ain3	Analog Input 3+ (Single-ended mode) or Analog Input 3+ (Differential mode).
Ain4	Analog Input 4+ (Single-ended mode) or Analog Input 3- (Differential mode).
5V Rf	+5 VDC reference output.
AGnd	Analog Ground: Common ground for analog inputs when used in single-ended mode and frequency ground.
Gnd	Digital Ground: Common ground connection for 5 VDC, Outputs, Inputs, Pulse Counters, and Temperature/ Humidity sensors.
5V Out	+5 VDC Output. Voltage output for inputs and for the digital temperature and humidity sensors
D I/O 1	Digital I/O 1: Configurable as logic inputs or outputs. Programmable pull-up resistors for input mode.
D I/O 2	Digital I/O 2: See above.
FreqIn	Frequency Input: AC frequency counter.
Data	Temperature/Humidity Data Input. Data connection for the digital temperature and humidity sensors.

2.2.1 Power Supply Connection

X-320™ requires power for its internal logic circuits. Connect a 9-28 VDC power supply to the Vin+ and Vin- terminals. Note that a regulated power supply is recommended, such as a wall-mount AC-DC adapter. Verify that the adapter is rated for the operating current of X-320™ (See **Appendix J: Specifications** for current requirements.)

Multiple X-320™ units may be connected to a single power supply by connecting the power supply input terminals in parallel. The power supply must have a high enough current rating to power all units connected. (See **Appendix J: Specifications** for current requirements.)

2.2.2 Digital I/O Connection

The Digital I/O's can be individually programmed to function as either inputs or outputs. When configured as inputs, a pull-up or pull-down resistors can be programmed. For unconnected inputs, the pull resistors will be read as ON, when pulled up, or OFF when pulled down.

Input Connection

The inputs can be configured to control remote relays, monitor the state of a discrete device, or one input can control the other output.

Pull-Up Resistor

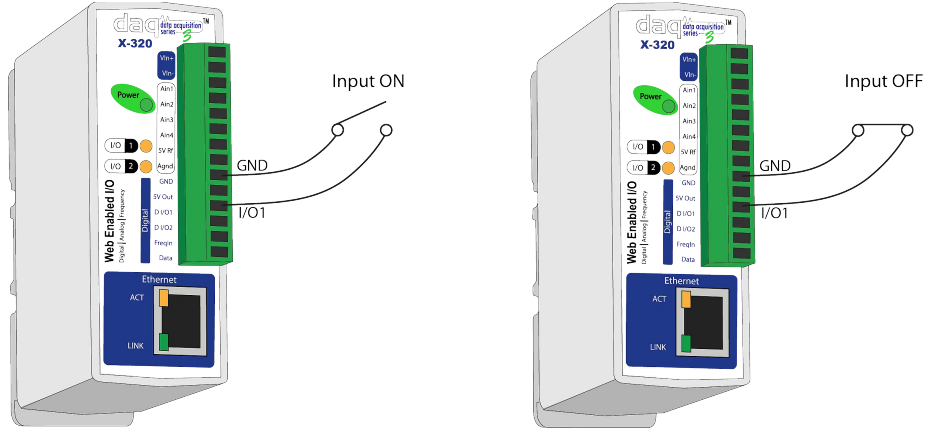

Figure 2.2a - Pull-Up Resistor Selected

Figure 2.2a illustrates how dry contacts can be connected to the input(s) of the X-320™ and use the pull up resistor. One side of the contact is connected to I/O1 or I/O2, and the other side is connected to Gnd. When the dry contact is closed, it closes the circuit, and the input is now tied to ground, which turns the input **OFF**.

Pull-Down Resistor

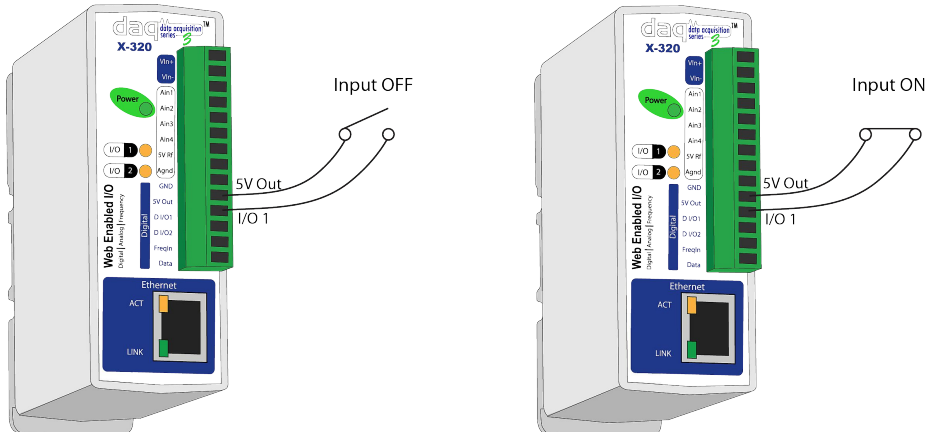

Figure 2.2b - Digital Input, Pull-Down Resistor Selected

Figure 2.2b illustrates how dry contacts can be connected to the inputs(s) of the X-320™ and use the pull-down resistor. One side of the contact is connected to I/O1 or I/O2 and the other side is connected to +5V Ref. When the dry contact is closed, it closes the circuit and applies 5V to the input terminals, which turns the input **ON**.

Output Connection

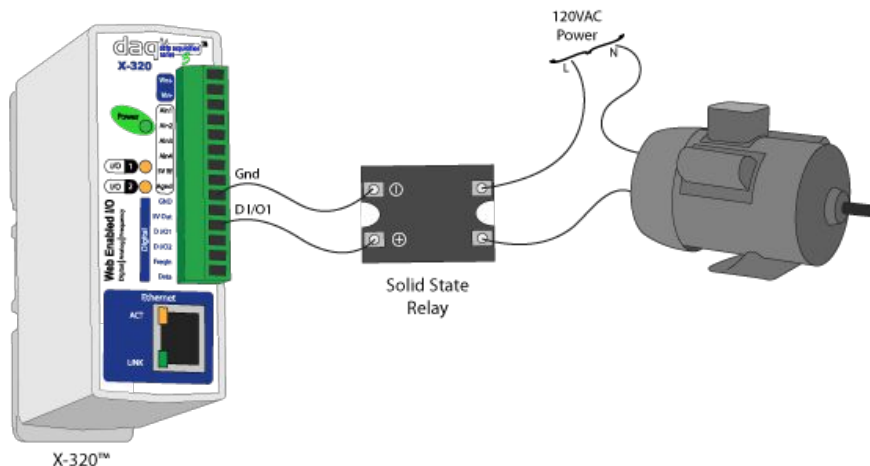

Figure 2.2c - Digital Output

When the Digital I/O is configured as an output, it can be used to supply a voltage to an external relay or device. Figure 2.2c illustrates how the Output can be used to actuate an external relay.

2.2.3 Analog Input

There are a variety of analog sensors that can be used with the Analog Inputs. To interface analog sensors to the inputs it may be necessary to add some simple external circuitry to limit the sensor voltage to the range of the Analog Input, 0-5 V. Analog sensors that provide an output voltage in the range of 0 to 5 volts can be directly connected to the inputs. Other common sensors have a higher output voltage of 0 to 10 volts, or output current in the range of 4 to 20 milliamps instead of voltage. These sensors can be connected to the Analog Inputs using simple resistive circuits shown below.

Some sensors, such as bridge-type sensors, have two output signals (differential) instead of one. The output signals from these sensors are referenced to each other instead of ground. Using these sensors requires that two inputs be used together in differential mode. Following are some examples of different sensor types and how they can be interfaced to the Analog Inputs.

High Output Sensors, > 5 VDC

In the case of a sensor whose output levels are higher than 5 volts, a simple voltage divider can be used to scale down the output. The following diagram shows a simple voltage divider circuit. In the example, V_{in} can range from 0 to 10 volts and resistor values for R1 and R2 will be chosen so that V_{out} will have a range that falls within the 0 to 5 volt range of the Analog Input.

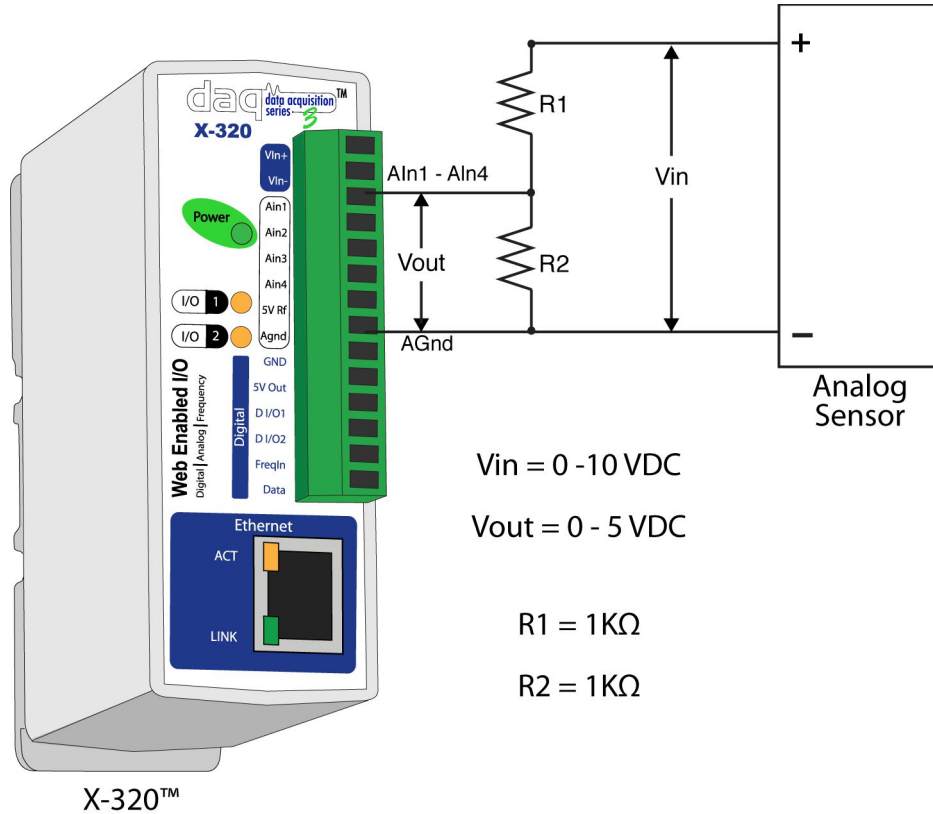

Figure 2.2d - Voltage Divider Circuit

Generally, you can choose a 1K Ohm resistor for R2 and then calculate the value of R1 using the following formula.

$$V_{out} = V_{in} * \left(\frac{R2}{R1 + R2} \right)$$

To determine the proper resistor value to use in the example above, use the maximum output of the sensor (10 VDC) as Vin in the equation, the maximum input value of the the Analog Inputs (5 VDC) as Vout, and R2 = 1K Ohms. Solving for R1 gives 1K Ohms

R1 = 1K Ohm

R2 = 1K Ohm

As another example, if the maximum output voltage of the sensors is 15 VDC, Choose R2 = 1K Ohm and by solving the equation, R1 = 2K Ohms.

4-20 mA Sensors (Current level conveys information, not voltage levels)

Some sensors are designed to change the output of the current instead of the voltage levels. To use these sensors, a resistor is placed in parallel with the sensors. Placing a resistor across the terminals of the sensor creates a voltage drop between them that changes as the current changes. This voltage drop can be measured by the Analog Module. The following diagram shows how to connect one of these sensors to the Analog Inputs.

For sensors that have an output of 4-20mA, a resistor value of 250 ohms can be used to get the desired output voltage between 0 and 5 volts. Ensure that the size of the resistor is appropriate to handle the power dissipation. A 20 mA sensor at 5 V will dissipate 1/4 W.

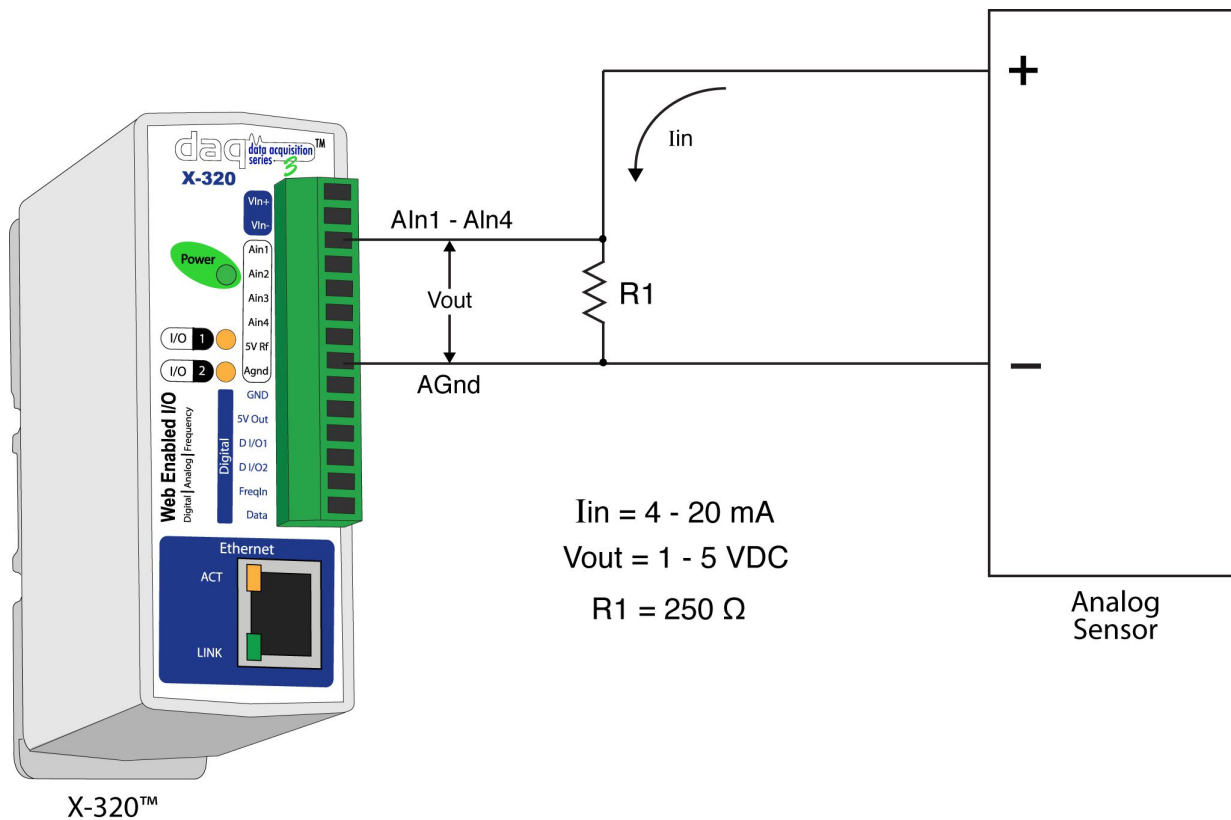
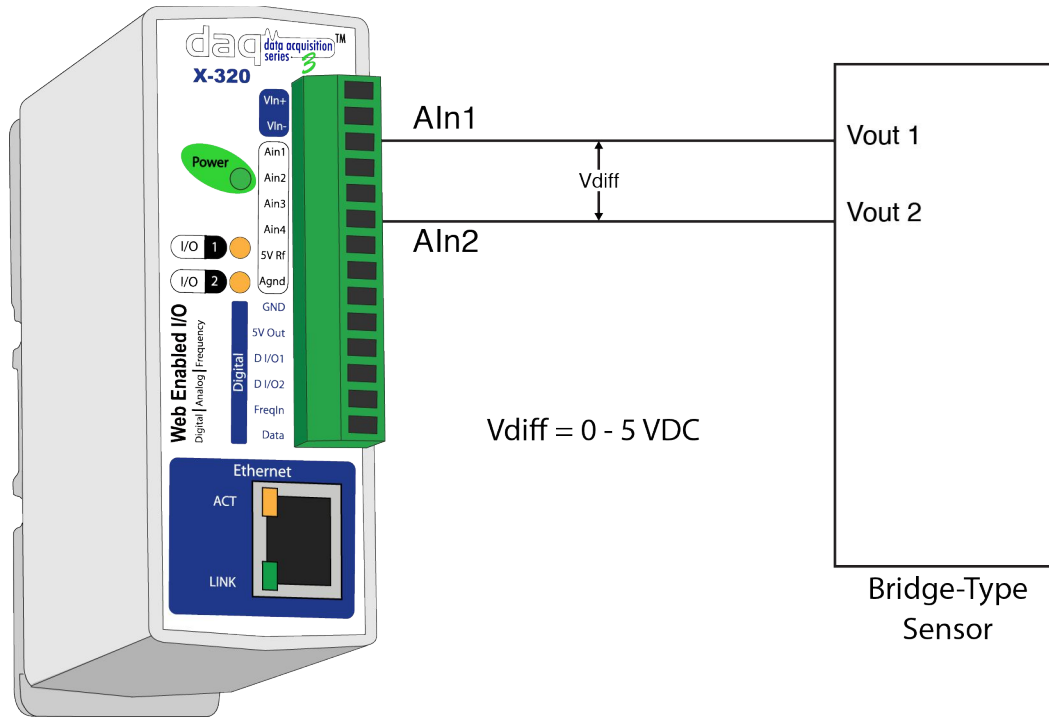

Figure 2.2e - Using a sensor with a 4-20mA output

Bridge-Type Sensors (Differential Mode)

Sensors that have an output that is referenced to ground are called single-ended sensors. Differential sensors have two outputs that reference each other instead of ground. The analog module can be used with both types of sensors. The mode is set by selecting the desired mode in the web-based setup pages. Note that differential mode uses two analog inputs instead of one. The following illustration shows how a differential sensors is connected to the Analog Inputs.



X-320™

Figure 2.2f - Differential Mode

The illustration above consists of a bridge-type sensor with two output signals. The outputs are connected to Analog Inputs 1 and 2. These two inputs have been placed in differential mode through the Analog Inputs setup page.

The analog reading taken by the X-320™ will be Vdiff, which is Vout 1 - Vout 2. If, for example, Vout 1 equals 2.5 volts and Vout 2 equals -2.5 volts, then the X-320™ will read 5 volts. If, on the other hand Vout 1 equals 2.5 volts and Vout 2 equals 2.5 volts, then the X-320™ a difference of 0 volts. When using sensors that provide two output signals make sure the sensor doesn't exceed the 5 VDC output for Vdiff. If the sensor is outside this range, external circuitry such as the voltage divider mentioned above should be used.

2.2.4 Frequency Input

Sensors that output a frequency can be connected to the Frequency Input. Connect one end of the sensor to FreqIn and the other to Gnd. Figure 2.2.g illustrates a flow rate sensor being connected to an X-320™.

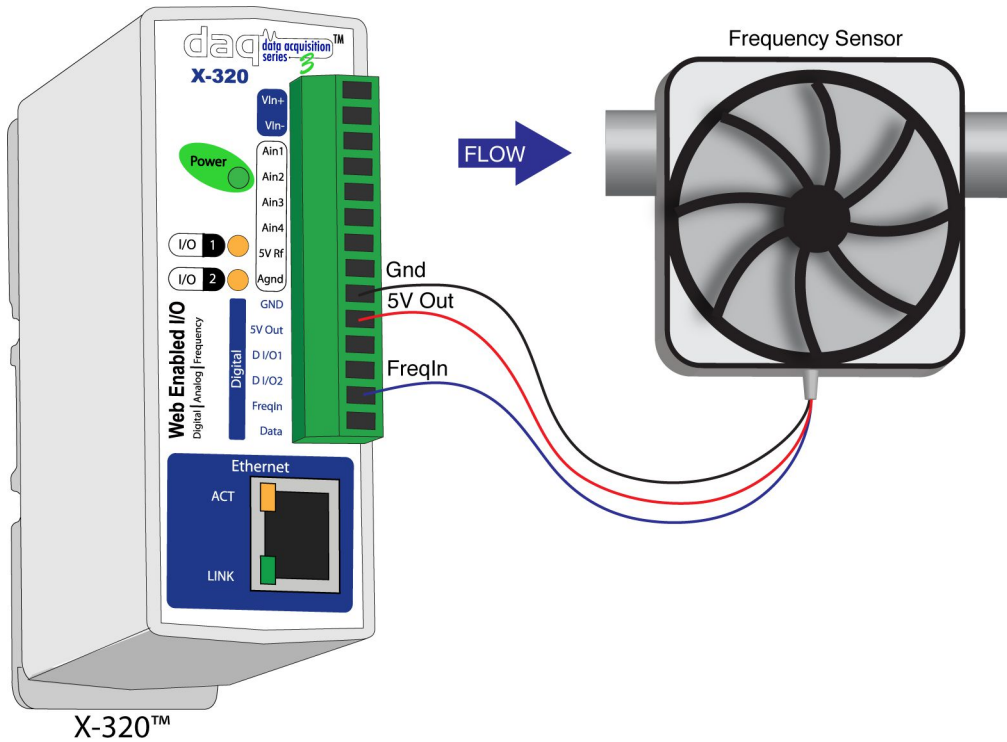

Figure 2.2g - Frequency Input

2.2.5 Temperature/Humidity Sensor Connection

Temperature or humidity sensors can be used for monitoring environmental conditions. The digital sensors use a one-wire data bus, which allows up to six sensors to share the same terminals (+5V, Ground, Data). Every sensor on the one-wire bus is assigned a unique serial number when it is manufactured. That number is used to address the device during communication.

The sensors have three wires; the wire color is show in the table below.



Figure 2.2h - Temperature Sensor

Sensor Wire Color	Connection
Red	5V Out
Black	Gnd
Blue (or White)	Data

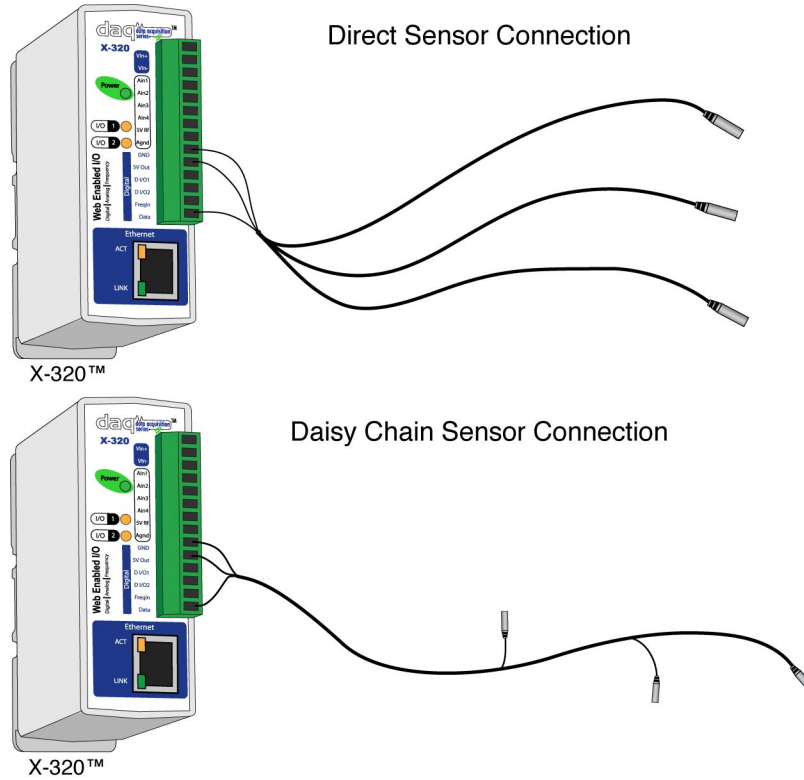

Figure 2.2i - Direct Connection (Star) and Daisy Chain Connection(Linear)

Multiple sensors can be connected in two ways, directly connected to the unit (star topology) or “daisy chained” (linear topology) as shown in Figure 2.2i. Many factors will determine the maximum length of cable used to connect sensors to X-320™. Some of these factors include, but are not limited to, the type of cable used, the number of sensors, ambient electromagnetic noise, and sensor network topology. Combined cable lengths to all sensors of 600 ft using Cat 5e cable have been successful. However, due to the uniqueness of installation environments, results may vary. Please test in the desired environment before permanent installation.

The following are general recommendations that will maximize sensor runs and minimize problems.

Cat 5 and Cat 5e network cable has proven to be an effective and low-cost solution for long runs. Other cable types can be used, but cable capacitance may limit the length. Figure 2.2j shows the recommended connection using Cat 5 network cable.

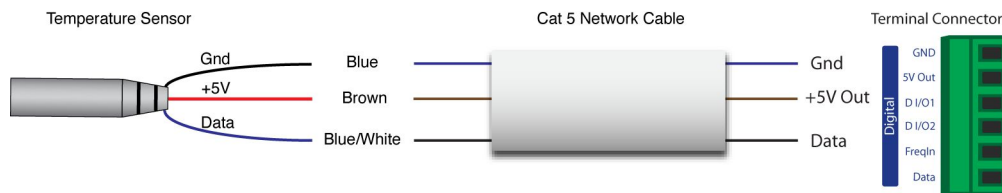

Figure 2.2j - Recommended connection using Cat 5 cable

A linear (daisy chain) topology will minimize signal reflections, providing a more reliable connection and longer cable length than a star topology.

Appropriate strain relief should be used at the X-320™ and other connections that may be subjected to vibration, movement, or repeated handling.

Avoid sensor runs adjacent to industrial equipment power cables. These cables can have high current spikes that may induce noise on the sensor signals. Similarly, avoid running sensor cables near any radio transmission antennas or coaxial feed-lines.

Protect any electrical connections with appropriate weather shielding.

Due to the broad range of applications and environments where the X-320™ may be employed, installation success on long sensor runs may vary significantly.

2.2.6 Network Connection

Connect the Ethernet port to a 10 Base-T or 10/100 Base-T Ethernet connection. This typically connects to an Ethernet hub, switch, or router. For configuration, X-320™ may be connected directly to the Ethernet port on a computer using a “crossover” cable. Otherwise, for connection through a hub or router, a standard “straight-through” cable should be used.

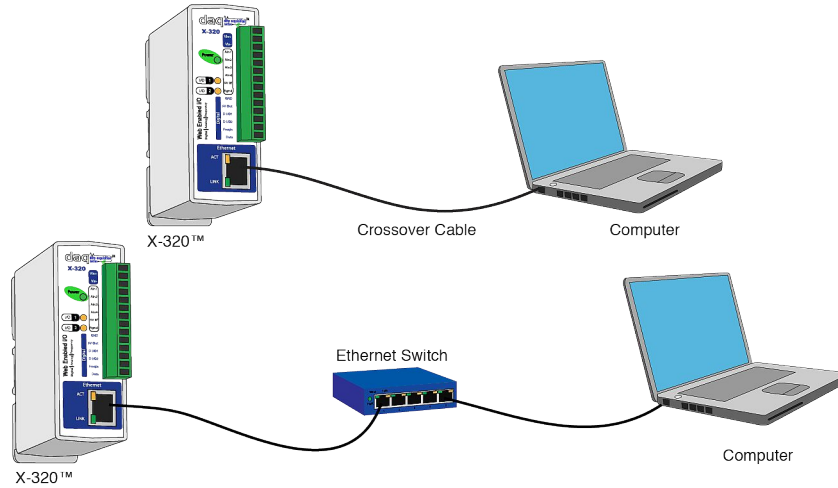

Figure 2.2k - Network Connection

X-320™ can be used on a wireless network by connecting through an Ethernet bridge or a wireless router.

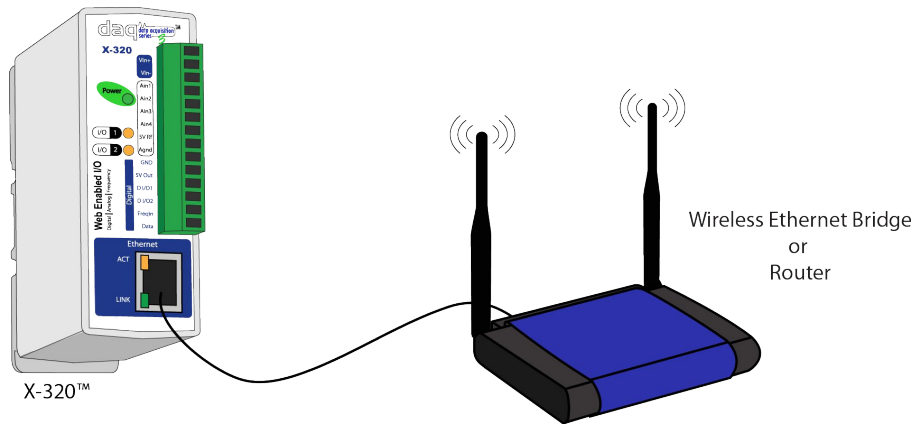

Figure 2.2l - Wireless Connection

Note: The wireless Ethernet bridge or router must be properly configured for the wireless network. Refer to the installation instructions for the wireless device.

2.3 Establishing Communications for Setup

In order to configure X-320™ with the web browser interface, X-320™ must be connected to an Ethernet computer network. This can be done by one of two methods:

Method 1 – Assign a temporary IP address to X-320™ to work on an existing network.

-or-

Method 2 – Temporarily change the IP address of a connected computer to match the default IP address used by X-320™.

Note: If multiple ControlByWeb™ products are used on the same network, install one at a time and set the IP address of each unit before connecting the next unit to the network. This avoids having multiple devices being installed on the network with the same factory default IP address at the same time. If this approach is used, be sure to clear the arp cache after disconnecting each unit (`arp -d`).

2.3.1 Method 1: Assign a Temporary IP address to X-320™

This option is used to TEMPORARILY assign an IP address to X-320™ without the need to change the IP address of the configuration computer. X-320™ will use this IP address as long as power is maintained. Once power is lost, X-320™ will use the IP address assigned in the setup page and not the temporary address assigned here.

Make sure that X-320™ and the configuration computer are connected to the same network.

This will not work through routers or gateways.

Microsoft Windows Instructions

1. Open a Command Prompt (select START, then RUN, then type “cmd”).

Note: For Vista, the Command Prompt should be run as administrator (select Start, then type “cmd” and right click on “cmd” and select “Run as administrator”).

2. Type:

```
arp -s {new IP address} {serial number of X-320™ }
```

Note: IP address format is xxx.xxx.xxx.xxx. The serial number can be found on a label on the module board. The format is ss-ss-ss-ss-ss-ss.

For example, to set X-320™ (with serial number 00-0C-C8-01-00-01) to 10.10.10.40 the following command would be used:

```
arp -s 10.10.10.40 00-0c-c8-01-00-01
```

3. Next, type:

```
ping -l 102 {new IP address}
```

For example, if the new IP address is 10.10.10.40, the following command would be used:

```
ping -l 102 10.10.10.40
```

4. Proceed with X-320™ setup in section 2.4.

Once setup is complete, it may be necessary to clear the 'arp' cache to configure additional WebRelays. This is necessary because each unit has the same default IP address, but a different unit serial number (MAC address). Clearing the arp table can be done by typing `arp -d` in the command prompt window.

Linux/Unix Instructions

1. Open a terminal and change to root user (su -, then enter root password).
2. Type:

```
arp -s {new IP address} {serial number of X-320™ }
```

Note: IP address format is xxx.xxx.xxx.xxx. The serial number can be found on a label on the module board. The format is ss:ss:ss:ss:ss:ss.

For example, to set X-320™ (with serial number 00-0C-C8-01-00-01) to 10.10.10.40 the following command would be used:

```
arp -s 10.10.10.40 00:0c:c8:01:00:01
```

3. Next, type:

```
ping -s 102 {new IP address}
```

For example, if the new IP address is 10.10.10.40, the following command would be used:

```
ping -s 102 10.10.10.40
```

4. Proceed with X-320™ setup in section 2.4.

Once setup is complete, it may be necessary to clear the 'arp' cache to configure additional WebRelays. This is necessary because each unit has the same default IP address, but a different unit serial number (MAC address). Clearing the arp table can be done by typing `sudo arp -d -a` in the command prompt window.

Mac OS X Instructions

1. Open a terminal.

Note: The terminal is in the "Utilities" directory, which is in the "Applications" directory.

2. Type:

```
sudo arp -s {new IP address} {serial number of X-320™ }
```

Administrator password may be required.

Note: IP address format is xxx.xxx.xxx.xxx. The serial number can be found on the label on the module board. The format is ss:ss:ss:ss:ss:ss.

For example, to set a X-320™ (with serial number 00-0C-C8-01-00-01) to 10.10.10.40 the following command would be used:

```
sudo arp -s 10.10.10.40 00:0c:c8:01:00:01
```

3. Next, type:

```
ping -s 102 {new IP address}
```

For example, if the new IP address is 10.10.10.40, the following command would be used:

```
ping -s 102 10.10.10.40
```

4. Proceed with X-320™ setup in section 2.4.

Once setup is complete, it may be necessary to clear the 'arp' cache to configure additional WebRelays. This is necessary because each unit has the same default IP address, but a different unit serial number (MAC address). Clearing the arp table can be done by typing `sudo arp -d -a` in the command prompt window.

2.3.2 Method 2: Assign a Temporary IP Address to Configuration Computer

If the first option above is not used, you can use this option to communicate with X-320™. By default, X-320™ comes from the factory with an IP address of 192.168.1.2. Communications with X-320™ may be established by assigning an IP address to the configuration computer that is on the same network as X-320™ (for example, the configuration computer could be assigned to 192.168.1.50)

The following example is for those running the Windows operating system:

1. Windows XP – Open the control panel by clicking on the start menu and then on Control Panel.

Windows Vista/7 – Select the Windows Icon (Start Menu) and enter `ncpa.cpl` into the search bar and press Enter (Figure 2.3a).

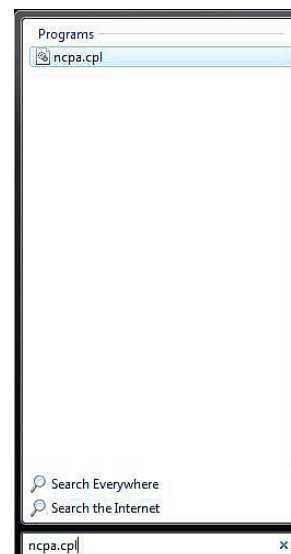

Figure 2.3a- Vista/7 Start Menu

Note: The control panel shown (Figure 2.3b) is in “Classic View.” If the control panel is in “Category View,” select the “Classic View” option before proceeding.

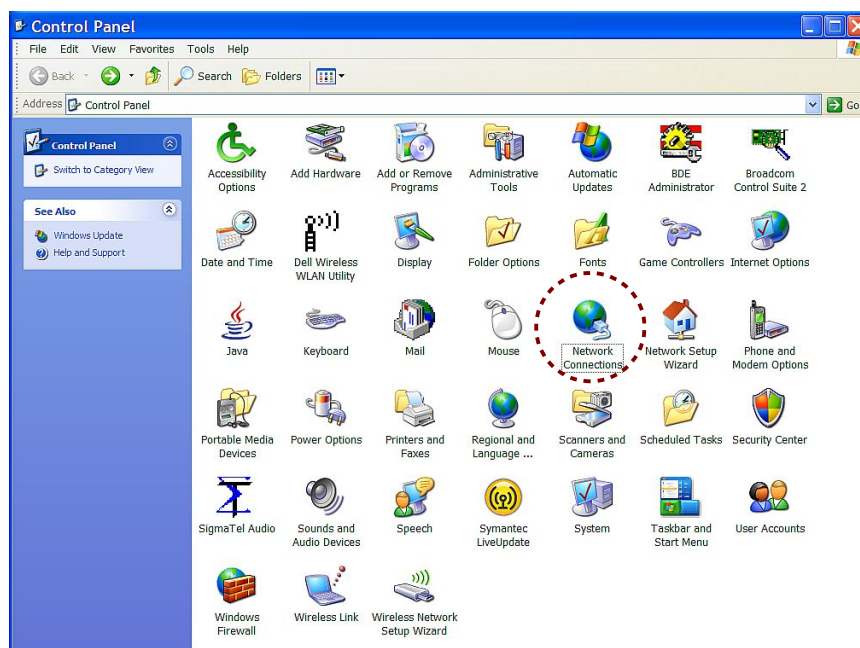

Figure 2.3b- Control Panel

2. Double click on the icon labeled Network Connections. The Network Connections window will open (Figure 2.3c).

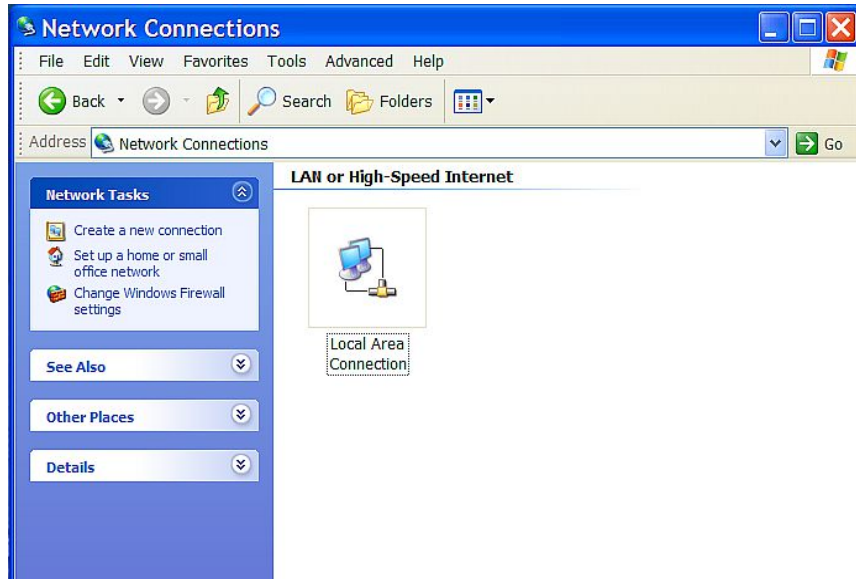

Figure 2.3c- Network Connection

3. Right click on the icon labeled Local Area Connection. In the menu that follows, select the option at the bottom of the menu labeled Properties. The Local Area Connection Properties window will appear (Figure 2.3d).

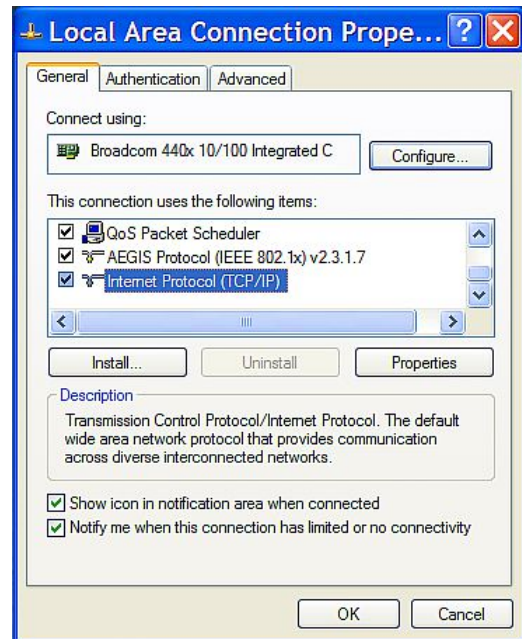

Figure 2.3d- Local Area Connection

4. In the Local Area Connection Properties window in the Connection Uses box, scroll down and highlight "Internet Protocol (TCP/IP)." Click the button labeled "Properties." The "Internet Protocol (TCP/IP)" Properties menu appears (Figure 2.3e).

Note: If "Use the following IP address" is already selected, the computer has been setup with a static IP address. Record these values so that the IP address of the computer can be restored once the IP address of the X-320™ has been successfully changed.

5. Select the radio button labeled "Use the following IP address" and type in the IP address:

192.168.1.50

6. Type in the subnet mask:

255.255.255.0

No need to change the default gateway field. Click OK to accept the new settings.

7. Open the setup pages as described in section 2.4. If the setup pages are not accessible, verify that X-320™ is powered on and that the LINK light is illuminated. Check all network connections and settings.

Another way to check communications is to ping X-320™ from the command prompt by typing ping {X-320™ IP address}.

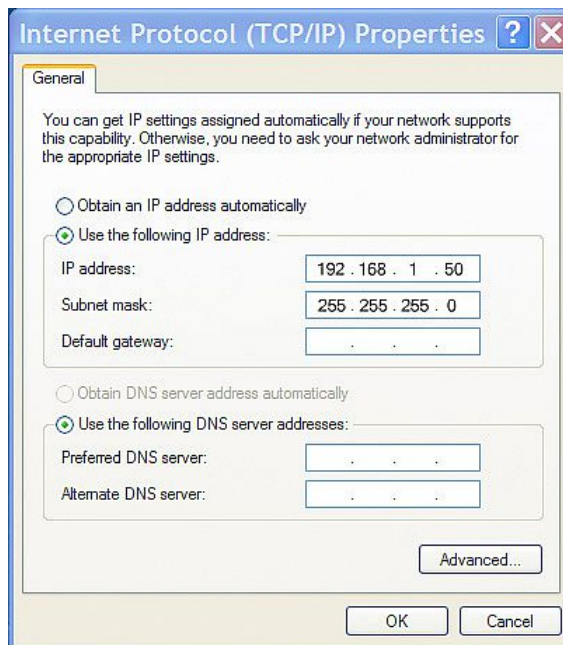

Figure 2.3e- TCP/IP Properties

2.4 X-320™ Setup Pages

X-320™ is configured using a web browser. To access the setup pages, enter the following URL in the address bar of a web browser:

```
http://{ipaddress}/setup.html
```

For example, using the default IP address, enter:

```
http://192.168.1.2/setup.html
```

After the page is requested, a password prompt will appear. Enter the username and password. The default username is `admin` and the default password is `webrelay` (password is case sensitive).

2.4.1 Main Tab

This is the initial page that is displayed when `setup.html` is entered into the address bar of the browser. It displays model and serial number information, and allows the user to select the desired temperature units.

The screenshot shows a web browser window with the address bar containing `192.168.1.2/setup.html`. The page header includes the **daq data acquisition series 3** logo and the **X-320** model name. Below the header is a navigation menu with the following tabs: **Main**, **Network**, **Advanced Network**, **Password**, **Date/Time**, **Logging**, **Digital I/O**, **Frequency Input**, **Analog**, **Sensors**, **Remote Relays**, **Events**, **Script**, **Control Page Setup**, and **Control Page**. The **Main** tab is selected, displaying the following information:

Units:	Fahrenheit <input checked="" type="radio"/> Celsius <input type="radio"/>
Part Number:	X-320-I
Firmware Revision:	0.5
Serial Number:	00:0C:C8:00:00:00
System Monitoring:	Internal Temp: 74.6 °F Vin Voltage: 12.0 Internal 6V Voltage: 6.3

At the bottom of the page, a note states: "For product support go to www.ControlByWeb.com Xytronix Research & Design, Inc."

Figure 2.4a - Main Tab

Units

This allows the user to select between the temperature units of **Fahrenheit** and **Celsius**. All settings entered and displayed on subsequent pages will be in the units selected.

Part Number

This is the full model number of X-320™.

Firmware Revision

This is the current product revision of the unit's firmware.

Serial Number

This is the serial number of this unit. The serial number is also the MAC address of the unit.

System Monitoring:

Internal Temp: This displays the current temperature inside the X-320™. Note that it is normal for this to be significantly higher than room temperature.

Vin Voltage: This is the DC voltage that is applied to the Vin+ and Vin- terminals.

Internal 6V Voltage: Internally, the unit operates on a 6 VDC power supply. This field is used to view the current value.

Note: The values in these fields are only updated when the webpage is refreshed.

2.4.2 Network Tab

The network parameters are set on this page.

*Note: X-320™ must be power-cycled (power disconnected, then reconnected) before network settings take effect. Only the settings on the **Network** tab require power-cycling before taking effect.*

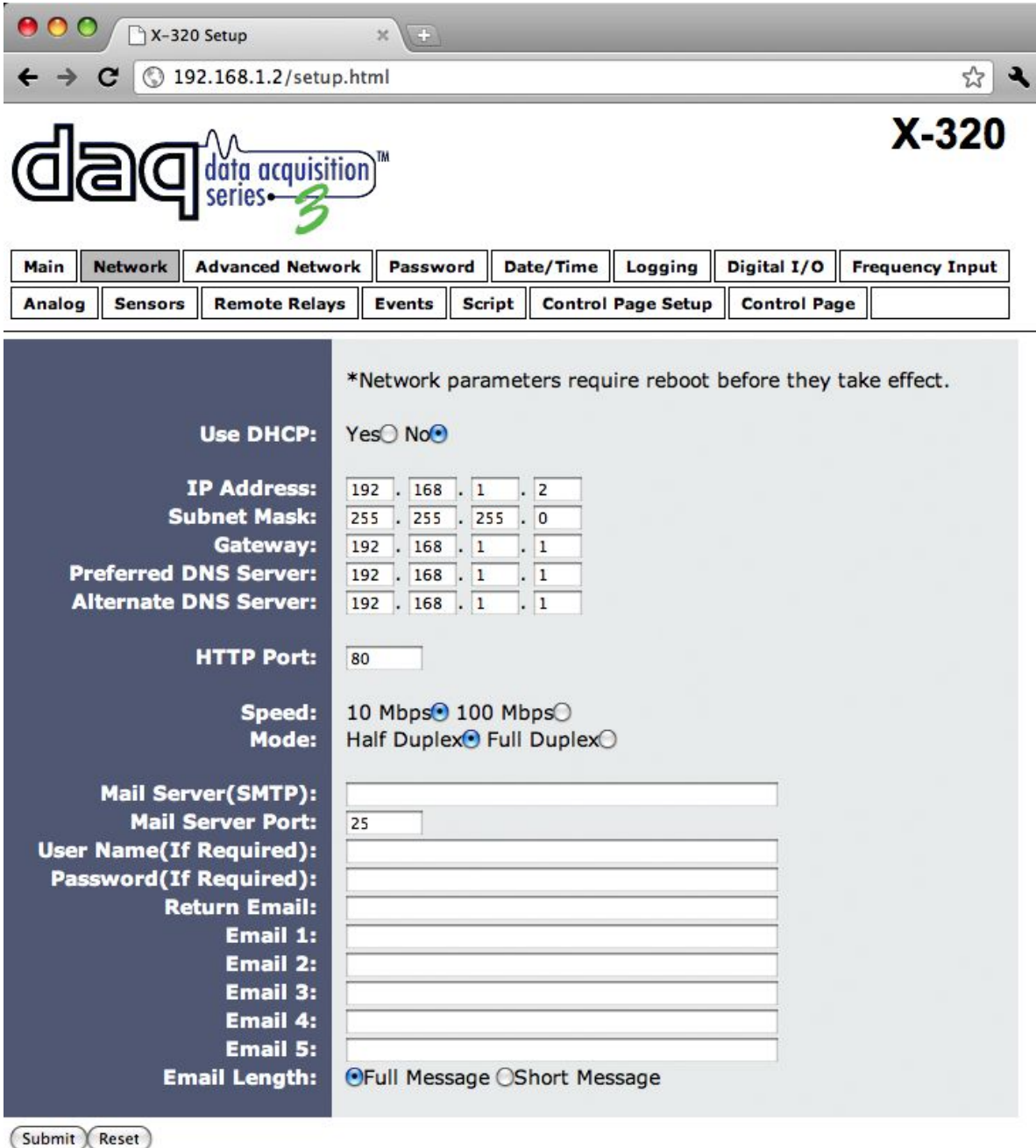

Figure 2.4b - Network Tab

Use DHCP

This option allows DHCP to be enabled or disabled. If this option is set to **Yes**, X-320™ will wait for an IP address from a DHCP server each time it is powered. The default setting is **No** (this is recommended for most installations). If DHCP is set to **Yes**, the Network page must be submitted and X-320™ must be rebooted before an IP address will be assigned. Once X-320™ is assigned an IP address by the DHCP, the new IP address can be found through the list of clients kept by the DHCP server. For most instances, this is found on the local gateway or router. (See **Brief Notes About DHCP** at the end of this section for more information.)

IP Address

Enter the IP address for X-320™ in this field. The IP address is specific to the network where X-320™ will be installed, and must be obtained from the network administrator. For more information on IP addresses and remotely accessing X-320™ over the Internet, see **Appendix C: Accessing X-320™ Remotely Over the Internet**. The default setting for this field is 192.168.1.2.

Subnet Mask

The subnet mask defines the size of the local network. This can be obtained from the network administrator. For additional information about sub-netting and IP networking, many tutorials are available on the Internet. The default setting for this field is 255.255.255.0.

Gateway

This specifies the IP address of the gateway router. This can be obtained from the network administrator. The default setting for this field is 192.168.1.1.

Preferred DNS Server

The IP address of the Primary DNS server is specified here. When DNS services are required, this is the address that will be used. The default setting for this field is 192.168.1.1.

This field is only required when the following options are used:

- **Remote Services** (when server is specified by name and not IP address).
- **Sync time clock with remote NTP server** (when server name is specified by name and not IP address).
- **Mail Server** (when server name is specified by name and not IP address).

Alternate DNS Server

This field is used to specify the IP address of a Secondary DNS server. This is used when X-320™ requires DNS services and the preferred DNS server is not available. The default setting for this field is 192.168.1.1.

HTTP Port

The TCP port used for HTTP communications (web browser, xml, get commands) with X-320™ is specified here. The default setting for this field is 80, which is the standard HTTP port. It is recommended that the port be left unchanged unless the user has an understanding of TCP/IP and ports. For more information on TCP ports and IP addressing see **Appendix C: Accessing X-320™ Remotely Over the Internet**.

Speed

This option sets the data rate (clock rate) of the Ethernet port. Either **10 Mbps** or **100 Mbps** can be selected. The **100 Mbps** option offers faster communications but the amount of data to and from X-320™ is so small that users will not likely notice much (if any) difference. When the X-320™ is set

to **10 Mbps**, it draws less power and runs a little cooler, which may translate into a longer product life. The default setting for this field is **10 Mbps**.

IT IS RECOMMENDED THAT THIS SETTING BE LEFT AT **10 Mbps** UNLESS THE USER HAS A SPECIFIC REASON TO USE **100 Mbps**.

Mode

This option allows the Ethernet port to be set to **Half Duplex** or **Full Duplex**. Legacy Ethernet operates in **Half Duplex** mode which means that devices can either send data or receive data, but not both at the same time. **Full Duplex** means that devices can send and receive data at the same time. The default setting for this field is **Half Duplex**.

Mail Server (SMTP)

The name of the SMTP (Simple Mail Transfer Protocol) mail server (for example mail.example.com) or the IP address of the mail server (for example 192.10.10.10) should be entered in this field. There is no default setting for this field.

Note: If the server name is entered and not the IP address, the address of a DNS server will be required.

Mail Server Port

This field is used to specify the SMTP Mail Server Port. The default setting is 25, which is the standard SMTP port.

User Name (If Required)

If the SMTP mail server requires authentication, the user name must be entered here. There is no default setting for this field.

Password (If Required)

If the SMTP mail server requires authentication, the password must be entered here. There is no default setting for this field.

Return Email

X-320™ will not receive email messages, but when X-320™ sends email messages, it must include a return email address. This field is used to specify the return email address. Note that although X-320™ will send email messages with any email address specified in this field, some email filters (spam filters) will not allow messages through that include an invalid email address. There is no default setting for this field.

Email 1 to Email 5

Enter the email addresses of up to five recipients for alarm messages in these fields. There are no default settings for these fields.

Email Length

Choose either “full” or “short” email lengths. When “full” is selected, all visible fields in the control page will be included in the email message to be sent out; however if “short” is selected, the email content will only be a brief description of what triggered the email message.

MTU Setting

To change the MTU, manually enter the advSetup.html (case sensitive) page into the address bar. (<http://192.168.1.2/advSetup.html>). This new setup page will have a text box that will allow the MTU to be changed. The valid range is 256 to 1476 bytes. MTU is a network parameter that stands for

Maximum Transmission Unit. This defines the max size, in bytes, of the TCP packets sent out from the device. This normally can be left alone, but there are some circumstances where it might be beneficial to change it. One of these circumstances is when the device is to be used over a VPN (virtual private network). VPN's add extra information to TCP packets, if the new packets are too big to physically travel across the network (greater than about 1500 bytes) then the packets will be split up. This causes problems for some firewalls and those firewalls will just discard the packets. To fix this, the MTU can be adjusted until the TCP packets do not get split up.

Brief Notes About DHCP

All devices on an IP network require an IP address. This is a unique address that identifies each device on the network. DHCP (Dynamic Host Control Protocol) is a mechanism that automatically assigns an IP address to a computer (or other devices) when it is connected to a network. This eliminates the need to manually enter the IP address. When a computer is connected to the network, another device on the network called a DHCP server detects the presence of the computer and dynamically assigns the IP address to that computer. On many small networks, the DHCP server is built into the router.

DHCP works well for "client" devices such as computers, but is not ideal for servers. This is because servers usually don't initiate communications with other devices, but rather they wait for a request from "clients." To make this request, the client must know the IP address of the server. If a server gets its IP address dynamically, the IP address may not always be the same so client devices may not be able to find the server. For this reason, servers usually use an IP address that is fixed and does not change. X-320™ is a server and manual IP address assignment is usually recommended.

2.4.3 Advanced Network Tab

Note: These settings are not used for most installations.

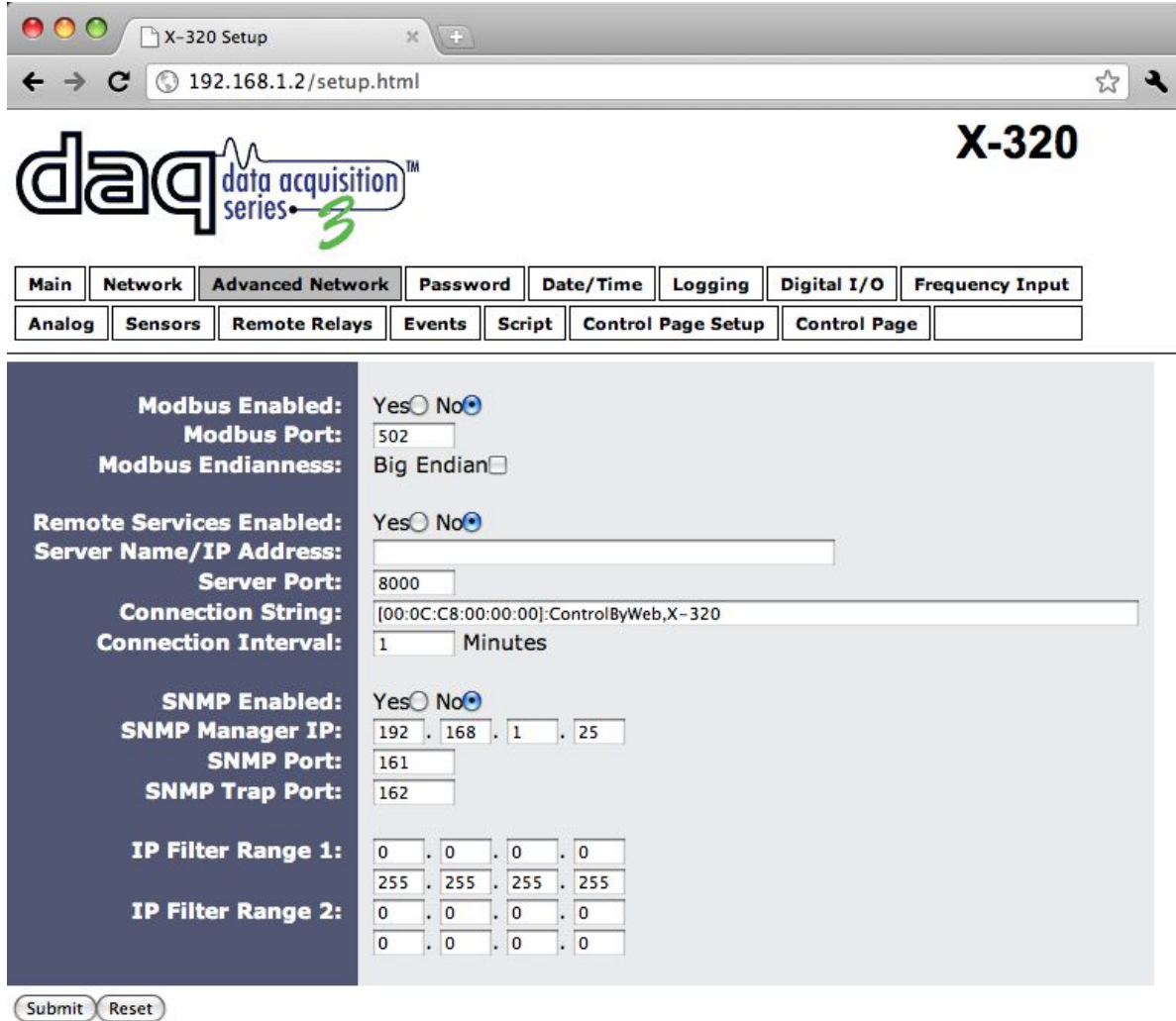

Figure 2.4c - Advanced Network Tab

Modbus Enabled

X-320™ can support Modbus/TCP. Modbus is a messaging structure protocol used in industrial manufacturing control and automation. It is an open protocol and offers interoperability with software and devices from other manufacturers. This is enabled by selecting **Yes** in this field. The default setting for this field is **No**. (See **3.4 Modbus Operation** for more information on using X-320™ on a Modbus network.)

Note: Modbus communications are disabled whenever the Control Password is enabled.

Modbus Port

This specifies the port used for Modbus/TCP communications with X-320™. By default this is set to port 502 which is the standard Modbus port. It can be set within the range of 0 to 65535.

Big Endian

32-bit data is treated as two individual 16-bit words using IEEE 754 floating point format. Floating point format is used for sensor, pulse counter, analog, and frequency data as well as for setting output pulse duration.

If the checkbox is set, the X-320™ will use big-endian architecture, and the most significant 16-bit word (big end) is sent first. If the box is cleared, then the X-320™ will use little-endian architecture, and the least significant word (little end) is sent first. The default setting for this box is **unchecked**, use little-endian.

For example, in little-endian format, a 32-bit floating point number represented by '1234 ABCD' is sent as 'ABCD 1234'.

Remote Services Enabled

This option enables or disables Remote Services. If **Yes** is selected, Remote Services will be enabled as soon as the submit button is pressed and X-320™ will immediately attempt to make a connection with the remote server (power cycle not required). Once a connection is established, the connection will remain until it is disconnected by the remote server. Proper connection with the remote server can be verified by viewing the system status log file (see **Appendix D: Log Files**). The default setting for this field is **No**. Most users should leave this setting at its default. (See **Remote Services** at the end of this section for more information.)

Server Name/IP Address

Specify the name or IP address of the Remote Services server here. If the IP address is specified, enter it in this format aaa.bbb.ccc.ddd. For numbers that are less than 100, preceding zeros should not be included (for example, enter 80 rather than 080). This field can be up to 40 characters long and has no default setting.

Server Port

Enter the TCP port used for the Remote Services server. This can be set within the range of 0-65535. The default setting for this field is 8000.

Connection String

This text is sent to the Remote Services server when the connection is established. This string should include any information required by the server at connection. For example, it may include an ID number, customer number, password, etc. The format is entirely dependent upon the server requirements. This field can be up to 80 characters long. Default text is provided only as an example placeholder. The default text is [`<Serial Number>`]:ControlByWeb,X-320.

Connection Interval

This field specifies the periodic interval in which X-320™ attempts to connect to the remote server, or if X-320™ is already connected, it is the interval in which X-320™ sends the connection string. This field can be set within the range of 1 to 34452 minutes. The default setting for this field is 1 minute.

SNMP Enabled

When this option is set to **Yes**, X-320™ will support SNMP. The default setting for this option is **No**. (See **SNMP** at the end of this section for more information.)

SNMP Manager IP

When SNMP is used, this field is used to specify the IP address of the SNMP manager. The default setting for this field is 192.168.1.25.

SNMP Port

When SNMP is used, this field is used to specify the SNMP port that X-320™ listens on. The default setting for this field is 161.

SNMP Trap Port

When SNMP is used, this field is used to specify the SNMP Trap port of the SNMP manager. The default setting for this field is 162.

IP Filter Range 1 and IP Filter Range 2

For additional security, X-320™ has a simple built-in firewall. If desired, X-320™ can be configured to only allow access to client devices (computers, servers, other ControlByWeb™ devices, etc) with certain IP addresses. Two IP address ranges are provided and only client devices with addresses that fall within those two ranges will be allowed access. Devices with IP addresses that fall outside of those ranges will not receive any response from X-320™. The following are examples.

To allow access from any device (this is the default setting):

IP Filter Range 1: 0.0.0.0
255.255.255.255

IP Filter Range 2: 0.0.0.0
0.0.0.0

To limit access to only one device (address 192.168.1.33):

IP Filter Range 1: 192.168.1.33
192.168.1.33

IP Filter Range 2: 0.0.0.0
0.0.0.0

To limit access to only devices on the local network and one device on the internet (address 10.143.100.32):

IP Filter Range 1: 192.168.1.0
192.168.1.255

IP Filter Range 2: 10.143.100.32
10.143.100.32

Note: The address specified for the Remote Services server (if applicable) is automatically allowed through the firewall no matter how the filter is set.

Remote Services

Remote Services initiates an outgoing connection to a server at a remote location. This can be used in an environment where a web server on the Internet provides a custom web page to X-320™ and other ControlByWeb products. Users access X-320™ through the web server rather than communicating directly with it. This method is sometimes referred to as “web services” and allows programmers to create powerful, custom web pages to multiple devices using the web programming languages of their choice.

Remote Services initiates the connection to the external web server (rather than the web server initiating communications to X-320™). This has two main benefits. First, the web server does not need to know

the IP address of X-320™. This means that X-320™ can get its IP address dynamically from a DHCP server, simplifying the installation. Second, since the connection from X-320™ is outgoing, rather than incoming, the local router on the network where X-320™ resides doesn't need to be configured to forward sockets. This also simplifies the installation. Since the router configuration is not modified, the risk of compromising security on the local network is eliminated. For more information about the **Remote Services** see **Appendix E: External Server and Remote Services**.

SNMP

Simple Network Management Protocol (SNMP) is used to manage and administer network devices. X-320™ supports SNMP V1.0 and can be configured here. Using SNMP, the I/O states of X-320™ can be read as well as some basic information about the device. See **Appendix F: SNMP Requests** for information about how to request information from X-320™ using an SNMP manager, as well as where to find MIB files for X-320™.

Note: The read and write community strings used for SNMP are actually the Control Password found on the Password setup tab (see Section 2.4.4). If the Control Password is disabled, then X-320™ does not check for the community string when issued a Get or GetNext request from the SNMP manager.

2.4.4 Password Tab

X-320™ requires a password to log into the setup pages. The password can be changed on this page. Additionally, a password can be enabled for the **Control Page**.

The screenshot shows a web browser window titled "X-320 Setup" with the address bar displaying "192.168.1.2/setup.html". The page features the "daq data acquisition series 3" logo and the "X-320" model name. A navigation menu includes tabs for Main, Network, Advanced Network, Password (selected), Date/Time, Logging, Digital I/O, and Frequency Input. Below this, a secondary menu includes Analog, Sensors, Remote Relays, Events, Script, Control Page Setup, and Control Page. The main content area is a dark blue sidebar with the following fields:

- Setup Password: [password field]
- Re-enter Setup Password: [password field]
- Enable Control Password: Yes No
- Control Password: [password field]
- Re-enter Control Password: [password field]

At the bottom of the sidebar are "Submit" and "Reset" buttons.

Figure 2.4d - Password Tab

Setup Password

The Setup Password, which is required to access the setup pages, can be modified by entering a new password here. Passwords that are 8 characters or longer (up to 13 characters can be entered in this field) with both alphabetic and numeric characters are recommended. For security purposes, the password will not be displayed as it is entered. Note that the username required for accessing the setup pages is `admin` (all lower case). The default Setup Password is `webrelay` (also all lower case).

Re-enter Setup Password

When the Setup Password is changed, it must be entered twice. One time in the previous field and a second time in this field. If the password is not entered identically in both fields, the password will not be changed.

Enable Control Password

The **Control Page** can be viewed without entering a password. For security purposes, a password can be required for access to the **Control Page**. When this field is set to **Yes**, a password will be required to view the **Control Page**. The default setting for this field is **No**.

*Note: The **Control Page** password will not take effect if Modbus is enabled. This is because Modbus has no provision for passing passwords.*

Control Password

When the Enable Control Password option above is set to **Yes**, this field is used to specify the password which will be required to access the **Control Page**. Passwords that are 8 characters or longer with both alphabetic and numeric characters are recommended. For security purposes, the password will not be displayed as it is entered. Note that X-320™ requires a password, but does not require a user name to access the **Control Page**. However, some browsers require that a user

name be entered. In this instance enter `none` as the user name. The default Control Password is `webrelay`.

Re-enter Control Password

When the Control Password is changed, it must be entered twice. One time in the previous field, and a second time in this field. If the password is not entered identically in both fields, the password will not be changed.

2.4.5 Date/Time Tab

X-320™ uses the time for scheduled events, such as turning the Outputs **ON** or **OFF** at scheduled times and for logging (a time stamp is included with each logged event). The time is stored and displayed in 24-hour time format. X-320™ has a capacitor-backed real-time-clock circuit that will keep track of time for several days in the event of a power failure.

The screenshot shows the X-320 Setup web interface. The browser address bar shows '192.168.1.2/setup.html'. The page title is 'X-320' and the logo is 'daq data acquisition series 3'. The navigation menu includes tabs for Main, Network, Advanced Network, Password, Date/Time, Logging, Digital I/O, and Frequency Input. The Date/Time tab is selected, showing the current date and time as 'Thu, 14 Apr 2011 09:30:25'. Below this, there is a 'Set Time:' dropdown menu set to 'Manually'. A calendar for April 2011 is displayed, with the 14th selected. The time is set to 09:30:00. There are also options for Daylight Savings, with 'Yes' selected. The interface includes 'Submit' and 'Reset' buttons at the bottom.

Figure 2.4e - Date/Time Tab - Set Time Manually

Current Date/Time

This is the current date and time stored in X-320™. The time is stored and displayed in 24-hour format.

Set Time

This drop-down list offers two options for setting the time: **Manually** or **Sync with NTP server**.

The options that follow this field will change based upon how this option is set.

- **Manually** requires the user to enter the time and date.
- **Sync with NTP server** allows the user to set the clock automatically by using an NTP (Network Time Protocol) server.

Manual Time Configuration

Date

The current date is entered by first selecting the correct month and year, using the left and right arrows at the top of the calendar. The single arrows (< and >) change the month and the double arrows (<< and >>) change the year. Once the current month and year are displayed, select the correct day, which will then be highlighted.

Time (24 Hour Format)

Enter the time as HH:MM:SS. (HH represents hours in 24-hour format [00-23], MM represents minutes [00-59], SS represents seconds [00-59].)

Figure 2.4f - Date/Time Tab - Sync with NTP Server

NTP Time Configuration

Server Name/IP Address

This field is used to specify the name or IP address of the NTP server. If a name is specified, a working DNS server address must be entered into the Network settings. If the IP address is specified, it should be entered in the following format `aaa.bbb.ccc.ddd` where each of the letters represents a number between 0 and 255. This field can be up to 40 characters. There is no default value for this field.

Many NTP Internet servers are available. In addition, many desktop computers will function as an NTP server (both Mac and PC). If a desktop computer is used, firewall settings may need to be adjusted to allow for NTP communications on port 123.

Public NTP servers can be found at www.pool.ntp.org. Some of these are listed below.

US Servers (<http://www.pool.ntp.org/zone/us>):

- 0.us.pool.ntp.org
- 1.us.pool.ntp.org
- 2.us.pool.ntp.org
- 3.us.pool.ntp.org

North America (<http://www.pool.ntp.org/zone/north-america>):

- 0.north-america.pool.ntp.org
- 1.north-america.pool.ntp.org
- 2.north-america.pool.ntp.org
- 3.north-america.pool.ntp.org

Europe (<http://www.pool.ntp.org/zone/europe>):

- 0.europe.pool.ntp.org
- 1.europe.pool.ntp.org
- 2.europe.pool.ntp.org
- 3.europe.pool.ntp.org

Australia (<http://www.pool.ntp.org/zone/au>):

- 0.au.pool.ntp.org
- 1.au.pool.ntp.org
- 2.au.pool.ntp.org
- 3.au.pool.ntp.org

South America (<http://www.pool.ntp.org/zone/south-america>):

- 0.south-america.pool.ntp.org
- 1.south-america.pool.ntp.org
- 2.south-america.pool.ntp.org
- 3.south-america.pool.ntp.org

Africa (<http://www.pool.ntp.org/zone/africa>):

- 1.africa.pool.ntp.org
- 1.pool.ntp.org
- 3.pool.ntp.org

Sync With Server

This option allows the user to specify how often the time on X-320™ will be synchronized with the time server. When the submit button on this page is pressed, X-320™ will immediately synchronize with the time server. If Daily, Weekly, or Monthly options are selected, X-320™ will thereafter re-synchronize with the time server at the period interval specified starting at 12:00 AM (00:00).

The exact time the NTP Request occurs is 12:00 AM (00:00) plus the minute equivalent of the last two digits in the model's serial number. For example, if the last two digits in the model's serial number were -09, the NTP Request will occur 9 minutes after 12:00 AM. The default value of this setting is Once (the unit will immediately sync with the NTP server, but will not automatically sync again).

Sync on Power Up

When this option is set to **Yes**, X-320™ will be synchronized with the time server each time it is powered.

*Note: If X-320™ will lose power on a frequent basis, it may be beneficial to set this option to **No**; some servers are configured to dis-allow access from client devices that excessively request their services. The default value of this setting is **No**.*

UTC Offset

Time servers return the current time in Universal Time (GMT). It is common for many servers and data loggers to use GMT as their official time, even when they are not located within the GMT time zone. The default value for this field is -7 (Mountain Standard Time). For convenience, the time can be converted to local standard time by entering the offset here. This manual cannot include the UTC Offset for all parts of the world, but the offset for GMT time and the four major US Time zones are listed here.

GMT Time: 0
Eastern Standard Time: -5
Central Standard Time: -6
Mountain Standard Time: -7
Pacific Standard Time: -8

Daylight Savings

In many parts of the United States and in some other countries, the time is shifted forward by one hour during the summer months. This is an effort to conserve energy by making the daylight last longer into the evening hours. If this option is set to **Yes**, the time on X-320™ will automatically be shifted forward by one hour between the hours of 12:00 AM – 5:00 PM on the Daylight Savings Start date set below, and it will shift back to standard time between the hours of 12:00 AM – 5:00 PM on the Daylight Savings End date set below. The time change is made at a random time within the previously mentioned, five-hour time frame, in order to prevent several different devices from simultaneously requesting a time and overwhelming the NTP server. The default setting is **Yes**.

Note: Enabling the daylight savings time adjustment, scheduled events will be adjusted for the new time. Logged data includes a time stamp based upon the current time in the device, so it is possible to duplicate log times in the spring and miss log times in the fall. To avoid confusion, many servers and data loggers are set to remain on GMT time and do not shift for daylight savings.

Daylight Savings Start

This is the date that daylight savings will start. Note that on this date, between the hours of 12:00 AM – 5:00 PM, the current time will be shifted forward by one hour (i.e. The time will jump from 12:02 AM [00:02] to 1:02 AM [01:02]). By default this is set to the 2nd Sunday in March which is the date used in the United States.

Daylight Savings End

This is the date that daylight savings will end. On this date, between the hours of 12:00 AM – 5:00 PM, the current time will be shifted backward by one hour (i.e. The time will jump from 12:02 AM [00:02] to 11:02 PM [23:02] the day before). By default this is set to the 1st Sunday in November which is the date used in the U.S.

2.4.6 Logging Tab

X-320™ can be configured to record data such as changes in I/O state, sensor data, and events. Both periodic and event-based logging are supported. The logged data is stored in internal nonvolatile memory and can be retrieved by entering the command `http://{X-320 IP address}/log.txt`. For more information on logging, see **Appendix D: Log Files**.

The log is stored in non-volatile, flash memory using a circular buffer (old date is over written). 512 kB of memory space is reserved for logging. Log entries are composed of the following components, 8-byte header, and 4 bytes for each log feature selected, except digital I/O, which is only one byte. A log of analog input 1 (4 bytes) and digital inputs (1 byte) will occupy 13 bytes per entry.

Note: Changing the log settings will erase the current log file.

The screenshot shows the 'X-320 Setup' web interface in a browser window. The address bar shows '192.168.1.2/setup.html'. The page features the 'daq data acquisition series 3' logo and the 'X-320' model name. A navigation menu includes tabs for Main, Network, Advanced Network, Password, Date/Time, Logging (selected), Digital I/O, and Frequency Input. Below this is a sub-menu with Analog, Sensors, Remote Relays, Events, Script, Control Page Setup, and Control Page.

The 'Logging Configuration' section includes the following settings:

- Logging Enabled: Yes No
- Start Time: 00 : 00
- Logging Rate: 60 Mins Hours Days Event Logging Only

A table lists various log features with checkboxes for 'Log' and 'Event Trigger', and a 'Trigger Delta' column with input fields:

	Log	Event Trigger	Trigger Delta
I/O 1	<input type="checkbox"/>	<input type="checkbox"/>	
I/O 2	<input type="checkbox"/>	<input type="checkbox"/>	
Counter 1	<input type="checkbox"/>	<input type="checkbox"/>	5.00000
Counter 2	<input type="checkbox"/>	<input type="checkbox"/>	5.00000
Rate 1	<input type="checkbox"/>		
Rate 2	<input type="checkbox"/>		
Frequency Input	<input type="checkbox"/>	<input type="checkbox"/>	5.00000 Hz
Analog 1	<input type="checkbox"/>	<input type="checkbox"/>	0.50000 V
Analog 2	<input type="checkbox"/>	<input type="checkbox"/>	0.50000 V
Analog 3	<input type="checkbox"/>	<input type="checkbox"/>	0.50000 V
Analog 4	<input type="checkbox"/>	<input type="checkbox"/>	0.50000 V
Sensor 1	<input type="checkbox"/>	<input type="checkbox"/>	2.00000 °F
Sensor 2	<input type="checkbox"/>	<input type="checkbox"/>	2.00000 °F
Sensor 3	<input type="checkbox"/>	<input type="checkbox"/>	2.00000 °F
Sensor 4	<input type="checkbox"/>	<input type="checkbox"/>	2.00000 °F
Sensor 5	<input type="checkbox"/>	<input type="checkbox"/>	2.00000 °F
Sensor 6	<input type="checkbox"/>	<input type="checkbox"/>	2.00000 °F
Vin	<input type="checkbox"/>	<input type="checkbox"/>	0.50000 V
Events	<input type="checkbox"/>	*	
XML Requests	<input type="checkbox"/>	*	
MODBUS Requests	<input type="checkbox"/>	*	
SNMP Requests	<input type="checkbox"/>	*	

Additional settings at the bottom:

- Filter Logged Requests: None Reads Writes
- Next Log Time: Event Logging Only

Buttons for 'Submit' and 'Reset' are located at the bottom left.

Figure 2.4g - Logging Tab

Logging Enabled

When this option is set to **Yes**, X-320™ will record data as configured on this page. The default setting for this option is **No**.

Note: This option controls data logging, but not system logging. System logging is always enabled.

Note: Logging of the Pulse Counter 1 or 2 will reduce the maximum counter rate to 25 Hz.

Start Time

If a logging interval is specified (periodic logging rather than event logging), logging will occur relative to this start time. For example, if the start time is 01:00 and the logging rate is 6 hours, logging will occur at 01:00, 07:00, 13:00, and 19:00. Start time is specified in 24-hour time format. The default setting for this field is 01:00.

Logging Rate

This field is used to specify the time period of logging. A numerical value is entered into the text field, and the unit of time is selected using the adjacent radio buttons. The range of values in this field is 1-20864. Time units are **Minutes**, **Hours**, and **Days**. Periodic logging can be disabled by selecting the Event Logging Only radio button.

Logging Configuration

This table is used to select which I/Os, pulse counters, frequency input, analog inputs, sensors, Vin and events get logged and which events trigger the logging. The first column in the table identifies the I/Os, pulse counters, sensors, etc. that can be logged or cause logging events. The second column is used to specify what gets logged. The third column is used to specify which events can cause a log entry to be created. The last column is used to specify the Trigger Delta for the corresponding I/Os, counters, and sensors.

When outputs are selected as an **Event Trigger**, logging will occur whenever the selected output is turned **ON** or **OFF**. When inputs are selected as an **Event Trigger**, logging will occur whenever the input state changes. When pulse counters, frequency input, analog input, sensors and Vin are selected as an **Event Trigger**, logging will occur whenever the input or sensor changes by the trigger delta.

The following **Log/Event Trigger** options are available:

- I/O (1-2)
- Pulse Counter (1-2)
- Pulse Rate (1-2)
- Frequency Input
- Analog V (1-4)
- Sensor (1-6)
- Vin
- Events
- XML Requests
- MODBUS Requests
- SNMP Requests

Note: When Analog Inputs are configured in Differential Mode, Analog Input 2 will read the same value as Analog Input 1, and Analog Input 4 will read the same value as Analog Input 3.

Note: When Event Trigger Logging is enabled for Pulse Counter input, the logging activity will affect rate accuracy for pulse rates above 25 Hz. Frequency inputs above 95 kHz are also affected by high logging rates.

Sensor Trigger Delta

X-320™ can be configured to log data when the count, frequency, voltage, temperature, or humidity measured by a sensor changes by the amount specified in this field. This can be set from 1.0 to 9999 units, in 0.1 increments. The default setting for these fields is shown below.

Sensor	Trigger Delta
Counters	5
Frequency	5 Hz
Analog	.5 V
Temperature	2°
Humidity	2%

Filter Logged Requests

When logging is enabled for XML Requests, Modbus Requests, or SNMP Requests, the user can filter out **Reads** (such as reading the Digital I/O states via an XML request) or **Writes** (such as changing the output state via an XML command).

On the **Control Page Setup** tab, the user can specify the refresh rate of the Control Page. Each time the page is refreshed, an XML request is sent and logged as a Read. Since the default refresh rate is 3 seconds, the log file can get cluttered by many XML request logs. By filtering out **Reads**, refresh requests will not be shown in the log. Likewise, by selecting **Writes**, any log created by changing the state of the output will not be shown in the log file. The default selection is **None**.

Next Log Time

This field displays the next periodic log time. If logging is disabled, the next log time will indicate "Disabled." If logging is enabled, but periodic logging is disabled (by selecting **Event Logging Only**) the next log time will indicate "Event Logging Only."

Note: This information is updated only when the page is refreshed.

2.4.7 Digital I/O Tab

This page provides configuration options for the two Digital I/O's built into the X-320™.

The Digital I/O may be configured as inputs or outputs. Different configuration pages are used for each of these modes.

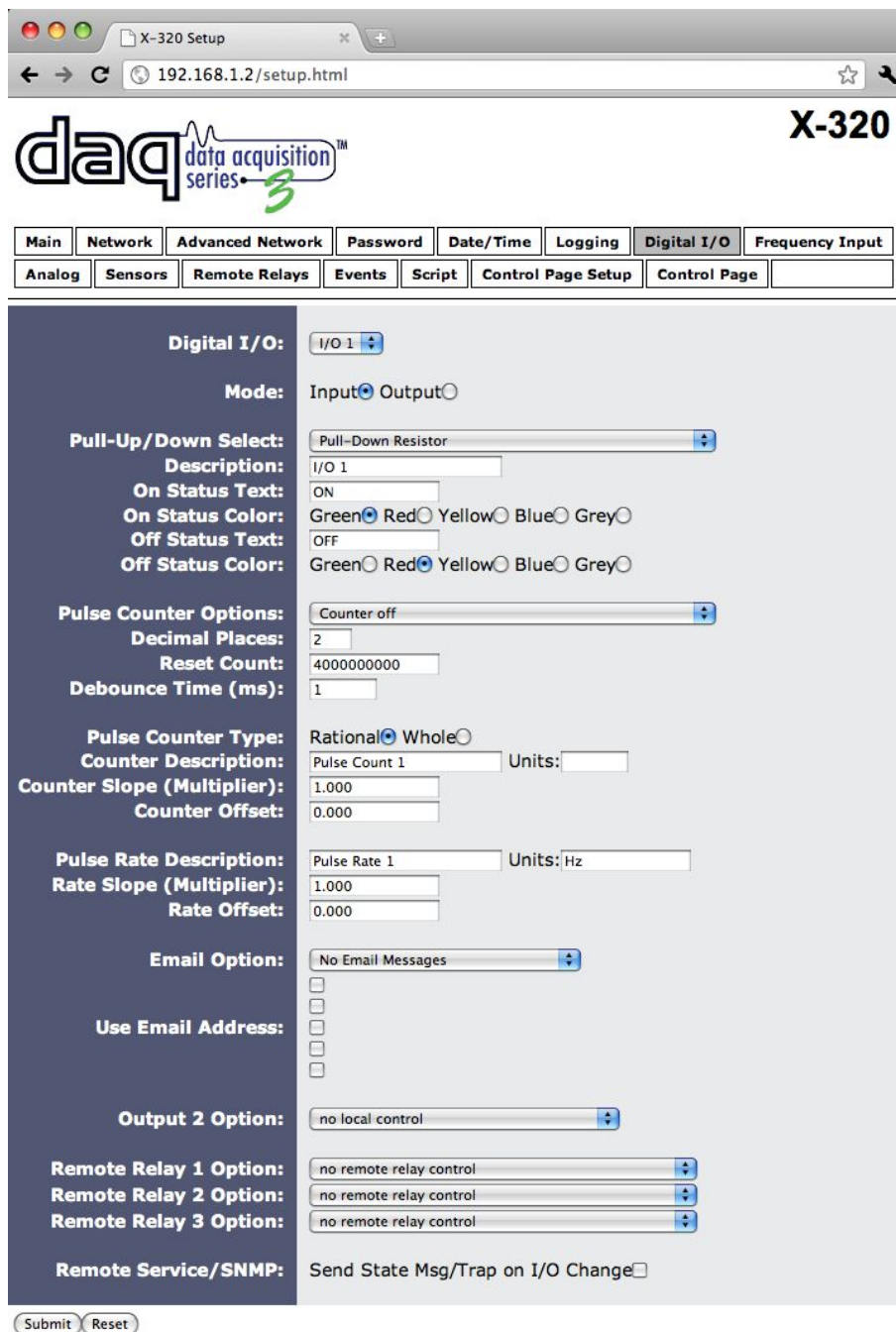

Figure 2.4h - Digital I/O Tab - Input Configuration

Digital I/O

A drop-down menu is used to select the control input to which the options below will apply.

- **I/O 1** or **I/O 2**: Selects the corresponding Digital I/O.

Mode

This selects whether the I/O will function as an **Input** or **Output**.

Input Mode

The following paragraphs describe the Digital Input functions show in Figure 2.4h.

Pull-Up/Down Select (Only displayed when Input mode is selected)

This drop down menu is used to configure the On/Off state of the I/O when configured as an input. When Pull-Up Resistor is selected, the input will be Off only when tied to ground. When Pull-Down Resistor is selected, the input is considered On when 5V is applied to the input.

*Note: The input is considered to be **OFF** when the input is tied to ground.*

Description

This text field is used to describe the function of the selected I/O. The text appears to the left of the corresponding input status on the **Control Page**, and in email messages when email alerts are enabled. This field may be up to 9 characters long. The default text is I/O #.

On Status Text

The text in this field specifies the text that will be displayed in the **Control Page** and in email messages when the I/O is **ON**. Up to 9 characters may be entered in this field. The default text is ON.

On Status Color

This field specifies the color that will be displayed on the control page when the I/O is considered On. Options are Green, Red Yellow, Blue, Grey. The default color is Green.

Off Status Text

The text in this field specifies the text that will be displayed in the control page and in email messages when the I/O is **OFF**. Up to 9 characters may be entered in this field. The default text is OFF.

Off Status Color

This field specifies the color that will be displayed on the control page when the I/O is considered Off. Options are Green, Red, Yellow, Blue, Grey. The default color is Red.

The following Options are only displayed when Input mode is selected

Pulse Counter Options

The inputs can be used as counters. This field specifies counter operation. Note that the input voltage must remain on or off for the minimum hold time (debounce time) before the counter will be incremented.

- **counter off**: The counter is deactivated and will not be incremented
- **increment when input on**: Each time the input is considered on, the counter will increment.
- **increment when input off**: Each time the input is considered off, the counter will increment.
- **increment when input changes**: Each time the input changes state, the counter will

increment.

Decimal Places

This text field is used to show higher precision after the decimal on the Control Page. The minimum number of decimal places shown is 0. The maximum number of decimal places shown is 5. The default for this field is 2.

When the Counter Type is set to Whole number mode, the decimal places are not shown.

Reset Count

The counter will reset to 0 as soon as the count reaches the value specified in this field. The counter is reset immediately when it reaches this value so this value will never be returned when the counter is read. For example, if the 'Reset Count' is set to 10, the counter will count from 0 to 9 and return to 0 on the next count. This value can be set from 1 to 4,000,000,000.

Debounce Time (ms)

All mechanical switches exhibit bounce, the electrical contacts make and break continuity rapidly when opened or closed. Digital circuits are fast enough to recognize these bounces as switch input activity. Some switches have shorter settling times than others. Solid-state or digital switches, such as signals from another electronic device, do not have any switch bounce.

The Debounce Time sets the minimum hold (debounce) time to allow for mechanical switches to settle in their new state. The default debounce setting is 20 ms, but may be set between 1 and 65535 ms. Due to internal circuit capacitance, the actual minimum is approximately 5 ms.

Note: The debounce time will effectively limit the pulse counter input rate. Users should set the debounce to allow for the maximum expected pulse rate. The debounce should be set to no more than ½ of the maximum expected cycle time. For example, a 100 Hz signal requires a debounce value of 5 ms or less.

Pulse Counter Type

This selects whether the counter will use **Rational** (default) numbers, and count using a fractional part (1, 1.25, 1.5, 1.75 ...) or **Whole** numbers (1, 2, 3, 4...).

When Counter Type is set to use Whole numbers, the maximum count is 4,294,967,294. For Rational mode, the maximum scaled value is 16,777,216, this is due to the limitations of floating point math used to calculate the scaled value.

Counter Description

This text field is used to describe the counter. The text appears to the left of the corresponding counter on the Control Page, and in email messages when email alerts are enabled. This field may be up to 9 characters long. The default text is Count:

Units

This text field is used to describe the units measured by the counter. The text appears to the right of the counter. This field may be up to 4 characters long.

Counter Slope (Multiplier)

The counter can be scaled to represent “real-world” units. The X-320™ reads the “raw” value from each counter, and calculates the number that represents the “real-world” measurement. This scaled value is calculated using the following linear formula.

$$\text{Scaled Value} = \text{Slope} * \text{Count} + \text{Offset}$$

The calculated scaled value is used for trigger logs, email messages, control page, XML page, and

returned when Modbus values are read.

The “slope” in the formula above is provided by the user and is entered in this field. The default value for this field is 1. When both the slope and offset are set to their default values, 1 and 0, respectively, the scaled value equals the actual Count.

When the counter is set to Whole number mode, the slope multiplier is truncated, all digits to the right of the decimal place are ignored.

Counter Offset

See the description of slope and offset in the previous paragraph

The “offset” in the formula above is provided by the user and is entered in this field. The default value for this field is 0. When both the slope and offset are set to their default values, the Scaled Value equals the Count value.

When the counter is set to Whole number mode, the offset is truncated, all digits to the right of the decimal place are ignored.

Pulse Rate Description

When the I/O is setup as an input counter, the average rate (frequency) of state change of the digital input is calculated over a 2 second period.

The digital input frequency is compatible with DC signals, such as simple logic level or switch inputs. The maximum frequency is limited by the Debounce Time and the logging status. When logging is enabled for the digital input, the input frequency is reduced due to the flash memory activity to make a log entry with each state change.

When Debounce Time is set to 1 ms and counter logging is disabled, the maximum rate is 25 Hz.

Note: When Event Trigger Logging is enabled for Pulse Counter input, the logging activity will affect rate accuracy for pulse rates above 25 Hz.

Units

This text field is used to describe the units measured by the Frequency Input. The text appears to the right of the frequency status, and in email messages when email alerts are enabled. This field may be up to 4 characters long.

Rate Slope (Multiplier)

In many cases, the Frequency Input must be scaled to represent “real-world” units. The X-320™ reads the “raw” value from the Frequency Input, and calculates a scaled value. The scaled value is calculated using the following linear formula.

$$\text{Scaled Value} = \text{Slope} * \text{Input Frequency} + \text{Offset}$$

The scaled value is the only number that the X-320™ keeps track of and uses. This is the value which is used to determine alarm conditions and is the value that is displayed on the control page, the XML page, and it is also returned when Modbus values are read.

The “slope” in the formula above is provided by the user and is entered in this field. The default value for this field is 1. When both the slope and offset are set to their default values, the Scaled Value equals the Raw Pulse Rate.

Rate Offset

See the description of slope and offset in the previous paragraph.

The “offset” in the formula above is provided by the user and is entered in this field. The default value for this field is 0. When both the slope and offset are set to their default values, 1 and 0,

respectively, the scaled value equals the actual Pulse Rate.

Email Option

Simple email messages can be sent in response to input changes. This parameter is used to specify what input changes, if any, will cause email messages to be sent. The default setting for this field is **No Email Messages**.

- **No Email Messages:** No email notifications will be sent due to input changes.
- **Send Email when input on:** Email notifications will be sent when input state changes to On.
- **Send Email when input off:** Email notifications will be sent when input state changes to **OFF**.
- **Send Email when input changes state:** Email notifications will be sent when input changes state to **ON** or **OFF**.

*Note: Email notification will work only if the email settings are correctly set up in the **Network** setup page.*

Use Email Address

If email messages are to be sent out based on input changes, these check boxes specify to which email addresses the message will be sent. Email addresses specified on the **Network** setup tab will be displayed next to each check box. By default, no boxes are checked.

Output

The local output may be set to activate based on the input state. The first drop down box specifies the action.

Note: Local output options will only appear if the other Digital I/O is configured as an output.

The following Actions are available:

- **no local control:** The input has no effect on the output.
- **set equal input:** When the input is considered On, the output turns On. When the input is considered Off, the output turns Off.
- **set opposite of input:** When the input is considered On, the output turns Off. When the input is considered Off, the output turns On.
- **latch when input on (reset via web):** When the input is considered On, the output turns On. Once the output is on it will stay on (unaffected by input change) until it is turned off manually via the web (or command) by a user, or the X-320™ is powered off. This option is useful for alarming functions.
- **latch when input off (reset via web):** When the input is considered Off, the output will turn On. Once the output is on, it will stay on (unaffected by input change) until it is turned off via the web (or command) by a user or the X-320™ is powered off. This option is useful for alarming functions.
- **latch when input changes (reset via web):** When the is input changes state, the output turns On. Once the output is on, it will stay on (unaffected by input changes) until it is turned off via the web (or command) by a user or the X-320™ is powered off. This option is useful for alarming functions.
- **toggle when input on:** When the input is considered On, the output will change states. When the input is considered off, the output will remain in its current state.
- **toggle when input off:** When the input is considered Off, the output will change states. When the input is considered on, the output will remain in its current state.
- **toggle when input changes:** When the input changes state, the output will also change states.

- **pulse when input on:** When the input is considered On, the output will Pulse for the Pulse Duration specified. The input may remain on or off and the pulse time will not be affected. If input changes state from On, Off, On before the end of the pulse time, the Pulse Duration timer will be restarted (it will restart each time the input is considered on) and the output will continue to remain on until the timer expires.
- **pulse when input off:** When the input is considered Off, the output will Pulse for the Pulse Duration specified. If the state of the input changes from Off, On, Off, before the end of the pulse time, the Pulse Duration timer will be restarted (it will restart each time the input is considered off) and the output will continue to remain on until the timer expires.
- **pulse when input changes:** When the input is considered On or Off, the output will Pulse for the Pulse Duration specified. If the change of state occurs before the end of the pulse, the timer will be restarted (it will restart each time the input changes state) and the output will remain on until the timer expires.

Remote Relay 1-3 Option

An input can be configured to control an output control relays on other ControlByWeb™ products at a remote locations. The Remote Relay Option drop-down settings are used to specify if remote relay actions.

The options in the drop down list are described below.

Note: Input changes will only affect the output or remote relay at the time the input is changed. Once the change has taken place, the state of the input has no effect on the state of the output or remote relay. In other words, if an input causes the remote relay to go on, a user may turn the remote relay off from the web browser, even if the local input is still on.

- **no remote relay control:** The input has no effect on the remote relay.
- **remote command equals input:** When the input is considered On, a command is sent to the remote relay to set the relay state to on. When the input is considered Off, a command is sent to the remote relay to set the relay state to off.
- **remote command opposite of input:** When the input is considered Off, a command is sent to the remote relay to set the relay state to On. When the input is considered On, a command is sent to the remote relay to set the relay state to Off.
- **send on command when input on (no off command):** When the input is considered On, a command is sent to the remote relay to set the relay state to On. When the input is considered Off, no commands are sent to the remote relay.
- **send on command when input off (no off command):** When the input is considered Off, a command is sent to the remote relay to set the relay state to on. When the input is considered On, no commands are sent to the remote relay.
- **send off command when input off (no on command):** When the input is considered Off, a command is sent to the remote relay to set the relay state to Off. When the input is considered On, no commands are sent to the remote relay.
- **send off command when input on (no on command):** When the input is considered On, a command is sent to the remote relay to set the relay state to Off. When the input is considered Off, no commands are sent to the remote relay.
- **send pulse command when input on:** When the input is considered On, a command is sent to the remote relay to Pulse the relay. When the input is considered Off, no commands are sent.
- **send pulse command when input off:** When the input is considered off, a command is sent to the remote relay to pulse the relay. When the input is considered on, no commands are sent.
- **send pulse command when input changes:** When the input is considered On, or Off, a command is sent to the remote relay to pulse the relay.
- **send toggle command when input on:** When the input is considered On, a command is

sent to the remote relay to toggle the relay (change the remote relay to the state opposite of its current state). When the input is considered Off, no commands are sent.

- **send toggle command when input off:** When the input is considered Off, a command is sent to the remote relay to toggle the relay (change the remote relay state to the state opposite of its current state). When the input is considered On, no commands are sent.
- **send toggle command when input changes:** When the input is considered On or Off, a command is sent to the remote relay to toggle the relay (change the remote relay to the state opposite of its current state).
- **remote relay equals input (heartbeat mode):** This is used for a “fail-safe” alarm configuration. This configuration is described as “fail-safe”, because it can be used to trigger an alarm if network or other equipment fails. This setting is used with a remote relay that controls the alarm. The alarm would be wired using the normally-closed contacts, so as long as the relay is ON, the alarm will remain OFF. Under normal conditions, the relay stays ON because the X-320™ sends periodic pulse messages that keep the relay turned ON. If an alarm condition occurs, the X-320™ will send a message to the remote relay unit to turn OFF the relay and sound the alarm. If there is an equipment failure (for example, the network switch failed), the remote relay will stop receiving the pulse messages. As soon as the pulse timer in the remote relay expires the remote relay turns OFF its relay and the alarm will sound. This can also be used with normally open contacts to ensure that a remote device doesn't remain on in case of a network failure.

When the option remote command equals input (heartbeat mode) is selected, Periodic State Interval must be set in the Remote Relay Tab. A range of 5-50 seconds can be used. Set the Periodic State Interval to just under half the pulse time specified in the remote relay. This configuration will cause the X-320™ to send a message to the remote relay at the interval rate specified by the Periodic State Interval. When the input is considered on, it will send pulse commands. When the input is considered off, it will send off commands. In addition to sending commands at the specified interval, commands will be sent each time the input changes state.

Remote Service/SNMP

When this box (Send State Msg/Trap on Input Change) is checked, SNMP traps and/or State messages will be sent whenever the input state changes.

The screenshot shows a web browser window titled "X-320 Setup" with the URL "192.168.1.2/setup.html". The page features the "daq data acquisition series 3" logo and the "X-320" model name. A navigation menu includes tabs for Main, Network, Advanced Network, Password, Date/Time, Logging, Digital I/O (selected), and Frequency Input. Below this is a secondary menu with Analog, Sensors, Remote Relays, Events, Script, Control Page Setup, and Control Page. The main content area is titled "Digital I/O:" and shows configuration for "I/O 1". The "Mode:" is set to "Output". The "Description:" is "I/O 1". The "On Status Text:" is "ON", and the "On Status Color:" is "Green". The "Off Status Text:" is "OFF", and the "Off Status Color:" is "Red". The "On Button Label:" is "ON", the "Off Button Label:" is "OFF", and the "Pulse Button Label:" is "PULSE". The "Pulse Duration:" is "1.500" Seconds, and the "State At Powerup:" is "off (unless overridden by event)". The "Email Option:" is "No Email Messages". There are four unchecked checkboxes under "Use Email Address:". The "Remote Service/SNMP:" option "Send State Msg/Trap on I/O Change" is unchecked. "Submit" and "Reset" buttons are at the bottom.

Figure 2.4i - Digital I/O Tab - Output Configuration

Output Mode

The following paragraphs describe the Digital Output mode configuration shown in Figure 2.4i.

On Button Label

The text entered in this field appears in the 'On' button for the corresponding output on the **Control Page**. Up to 9 characters may be entered in this field. The default text is **ON**.

Off Button Label

The text entered in this field appears in the 'Off' button for the corresponding output on the **Control Page**. Up to 9 characters may be entered in this field. The default text is **OFF**.

Pulse Button Label

The text entered in this field appears in the 'Pulse' button for the corresponding output on the **Control Page**. Up to 9 characters may be entered in this field. The default text is **PULSE**.

Pulse Duration

When the X-320™ receives a pulse command for the output (through the web page or through a command), the output will pulse for the time specified in this field. Note that when a pulse command is sent through the command interface, the command can include a pulse time which will over-ride this value (for that pulse only). The time is specified in seconds and can range from 0.1 seconds to 86400 seconds in 0.1 second increments. The default time is 1.5 seconds.

State at Powerup

This drop down menu lets the user specify the state of each of the output when the X-320™ is powered up. The following options can be selected:

- **off (unless overridden by event)**: The output will be off upon power up. This is the default setting.
- **on (unless overridden by event)**: The output will be on when power is applied to the X-320™.
- **last state (unless overridden by event)**: Upon power up, the output will return to its last state when the X-320™ was powered off.

Email Option

Simple email messages can be sent in response to input changes. This parameter is used to specify what input changes, if any, will cause email messages to be sent. Note that email notification will work only if the email settings are correctly set up in the **Network** setup page. The following options are available:

- **No Email Messages**: No email notifications will be sent due to input changes.
- **Send Email when input on**: Email notifications will be sent when input state changes to ON.
- **Send Email when input off**: Email notifications will be sent when input state changes to OFF.
- **Send Email when input changes state**: Email notifications will be sent when input changes state to ON or OFF.

*Note: The default setting for this field is **No Email Messages**.*

Use Email Address

If email messages are to be sent out based on output changes, these check boxes specify to which email addresses the message will be sent. Email addresses specified on the **Network** setup tab will be displayed next to each check box. By default, no boxes are checked.

Remote Service/SNMP

When this box (Send State Msg/Trap on Input Change) is checked, SNMP traps and/or State messages will be sent whenever the I/O state changes. Remote Services or SNMP must be enabled and properly configured for this feature to be effective.

2.4.8 Frequency Input Tab

This page provides configuration options for the Frequency Input. The Frequency Input can be connected to AC and DC signals up to 20 V peak to peak and a maximum frequency of 130 kHz.

Note: Frequent logging activity (above about 5 entries per second) may affect accuracy for frequencies greater than 95 kHz.

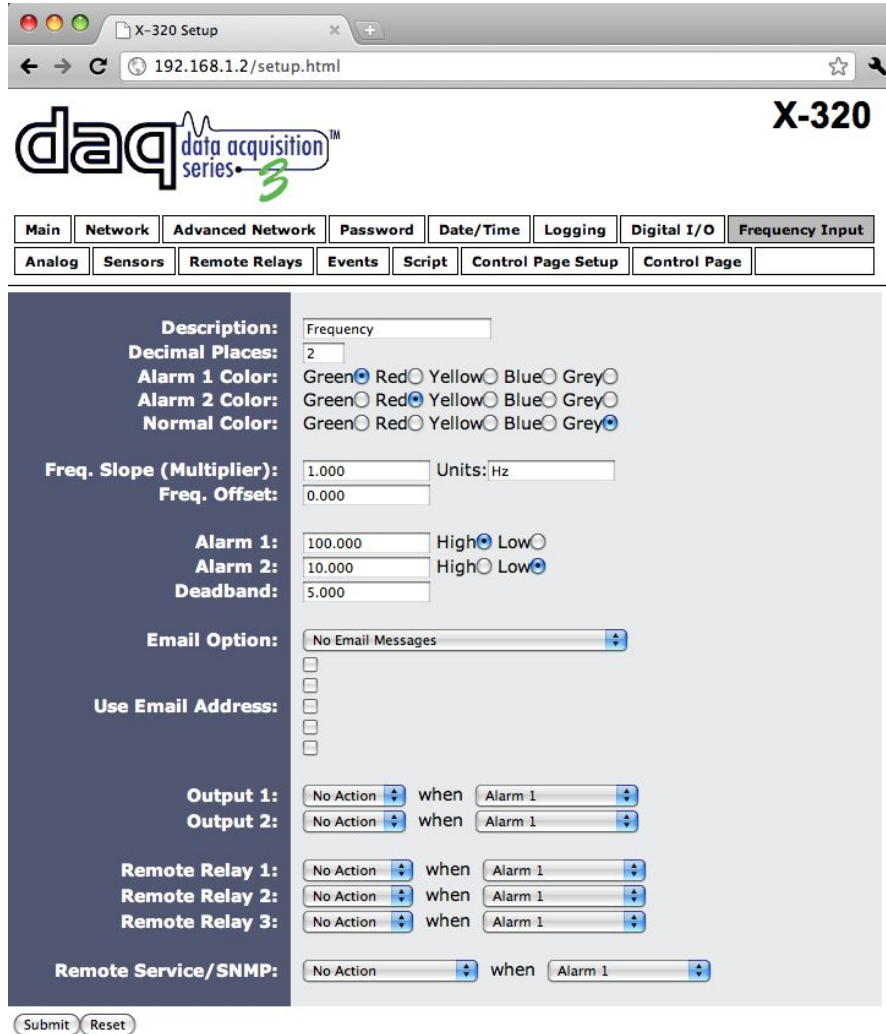

Figure 2.4j - Frequency Input

Description

This text field is used to describe the function of the Frequency Input. The text appears to the left of the Frequency Input status on the Control Page. This text will also appear in email messages when email alerts are enabled. This field may be up to 9 characters long.

Decimal Places

This text field is used to show higher precision after the decimal on the Control Page. The minimum number of decimal places shown is 0. The decimal places are truncated, not rounded. A displayed value of 1.99 Hz will display as 1 if the field is set to 0. The maximum number of decimal places

shown is 5. The default for this field is 2.

Alarm 1 Color

This field specifies the color that will be displayed on the Control Page when Alarm 1 is reached. Options are Green, Red, Yellow, Blue, Grey. The default setting is Green.

Alarm 2 Color

This field specifies the color that will be displayed on the Control Page when Alarm 2 is reached. Options are Green, Red, Yellow, Blue, Grey. The default setting is Red.

Normal Color:

This field specifies the color that will be displayed on the Control Page when the frequency is Normal. Options are Green, Red, Yellow, Blue, Grey. The default setting is Grey.

Freq. Slope (Multiplier)

In many cases, the Frequency Input must be scaled to represent “real-world” units. The X-320™ reads the “raw” value from the Frequency Input, and calculates a scaled value. The scaled value is calculated using the following linear formula.

$$\text{Scaled Value} = \text{Slope} * \text{Input Frequency} + \text{Offset}$$

The scaled value is the only number that the X-320™ keeps track of and uses. This is the value which is used to determine alarm conditions and is the value that is displayed on the control page, the XML page, and it is also returned when Modbus values are read.

The “slope” in the formula above is provided by the user and is entered in this field. The default value for this field is 1. When both the slope and offset are set to their default values, the Scaled Value equals the Raw Frequency.

Units

This text field is used to describe the units measured by the Frequency Input. The text appears to the right of the frequency status, and in email messages when email alerts are enabled. This field may be up to 4 characters long.

Offset

See the description of slope and offset in the previous paragraph.

The “offset” in the formula above is provided by the user and is entered in this field. The default value for this field is 0. When both the slope and offset are set to their default values, 1 and 0, respectively, the scaled value equals the actual Input Frequency.

Alarm 1

This setting is used to set the trigger point for an alarm condition. The number field specifies the frequency at which the alarm is triggered. The High and Low radio buttons indicate whether the alarm is triggered as a high or low alarm. A high alarm is triggered when the frequency at the sensor exceeds the alarm set point, and a low alarm occurs when the frequency at the sensor is lower than the alarm set point.

Alarm 2

This is a second alarm trigger that works identical to Alarm 1.

Deadband

This option sets the deadband used when evaluating alarm conditions. Deadband prevents alarms from triggering excessively when the sensor measurement vacillates quickly around the set point due to normal fluctuations. Deadband on high alarms requires the measurement to fall below the high alarm point minus the deadband before the high alarm can be triggered again. Likewise the deadband on the lower alarm requires the measurement to rise above the low alarm point plus the deadband before the low alarm can be triggered again. For example, if the deadband is set to 50 Hz, and a high alarm is to occur at 150 Hz, the dead band ensures that once the high alarm is triggered, it won't go off until the temperature returns below 100 Hz ($150 - 50$). This reduces problems with small fluctuations in sensor readings triggering multiple alarms.

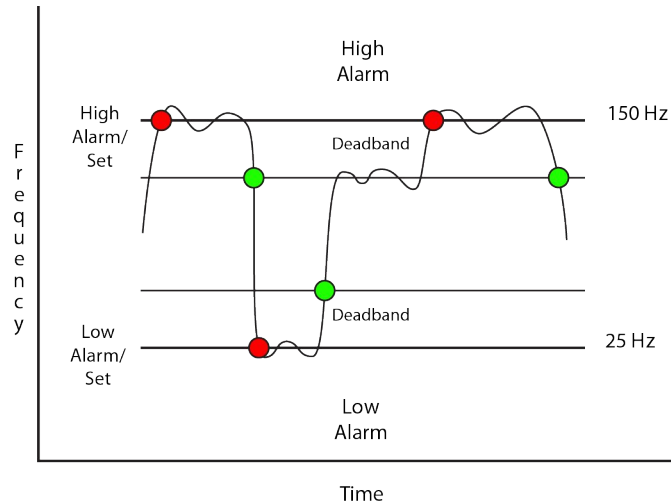

Email Option

Simple email messages can be sent in response to alarm conditions. This parameter is used to specify what alarm conditions, if any, will cause email messages to be sent. Note that email notification will work only if email is correctly setup in the **Network** setup page.

- **No Email Messages:** No email messages will be sent due to alarm conditions.
- **Send Email on Alarm 1:** Email notifications will be sent due to Alarm 1 conditions.
- **Send Email on Alarm 2:** Email notifications will be sent due to Alarm 2 conditions.
- **Send Email on Alarm 1 and Alarm 2:** Email notifications will be sent due to Alarm 1 or Alarm 2 conditions.
- **Send Email on Alarm 1, Alarm 2, and Normal:** Email notifications will be sent due to Alarm 1, Alarm 2, or when Normal conditions are regained.

Use Email Address

If email messages are to be sent out based on alarm conditions, these check boxes specify to which email addresses the message will be sent. Email address specified on the Network setup tab will be shown next to each check box.

Output 1 or Output 2

This field is used to set the action that the corresponding Output will have due to an alarm condition. The first drop down box specifies the action.

Note: This option will only appear if one of the Digital I/O is selected as an output.

The following Actions are available:

- **No Action:** No action is taken by the output.
- **Turn On:** Turns the output on due to an alarm condition. The output will turn off when alarm conditions are no longer met
- **Turn Off:** Turns the output off due to an alarm condition. The output will turn on when alarm conditions are no longer met.
- **Pulse:** Pulses the output for a specified amount of time due to an alarm condition.
- **Latch On:** Turns the output On due to an alarm condition. Once the output is on, it will stay on (unaffected by alarm conditions) until it is turned off via the web by a user or the X-320™ is powered off. This option is useful for alarming functions.
- **Latch Off:** Turns off the output due to an alarm condition. Once the output is off, it will stay off (unaffected by alarm conditions) until it is turned on via the web by a user or the X-320™ is powered off. This option is useful for alarming functions.

The second drop down box specifies the conditions that will cause the action previously specified. The following conditions are available:

- **Alarm 1:** The specified output action occurs due to Alarm 1.
- **Alarm 2:** The specified output action occurs due to Alarm 2.
- **Alarm 1 or Alarm 2:** The specified output action occurs due to Alarm 1 or Alarm 2.

Remote Relay 1-3

The X-320™ can be configured to control relays in other ControlByWeb™ products that are located at a remote locations on the network. This field determines the action taken by Remote Relay due to an alarm condition. The following actions are available:

- **No Action:** No action is taken by the relay.
- **Turn On:** Turns the relay on due to an alarm condition. The relay will turn off when alarm conditions are no longer met.
- **Turn Off:** Turns the relay off due to an alarm condition. The relay will turn on when alarm conditions are no longer met.
- **Pulse:** Pulses the relay for a specified amount of time due to an alarm condition.
- **Latch On:** Turn on the relay due to an alarm condition. Once the relay is on, it will stay on (unaffected by alarm conditions) until it is turned off via the web by a user or the X-320™ is powered off. This option is useful for alarming functions.
- **Latch Off:** Turns off the relay due to an alarm condition. Once the relay is off, it will stay off (unaffected by alarm conditions) until it is turned on via the web by a user or the X-320™ is powered off. This option is useful for alarming functions.
- **Send Value:** Sends the scaled value to the remote unit.

The second drop down box specifies the conditions that will causes the action previously specified.

- **Alarm 1:** The specified relay action occurs due to Alarm 1.
- **Alarm 2:** The specified relay action occurs due to Alarm 2.
- **Alarm 1 or Alarm 2:** The specified relay action occurs due to Alarm 1 or Alarm 2.
- **Value Changes:** The action is applied when a new value is read from the input.

Remote Service/SNMP

This field specifies the action with a remote server due to an alarm condition.

- **No Action:** No action is taken.
- **Send State Msg/Trap:** An event string will be sent to the remote server.

For more information regarding the event string or other commands, see **Appendix F: Remote Services**.

The second drop down box specifies the conditions that will cause an alarm trigger. The following alarm conditions are available:

- **Alarm 1:** The specified action occurs due to Alarm 1.
- **Alarm 2:** The specified action occurs due to Alarm 2.
- **Alarm 1 or Alarm 2:** The specified action occurs due to Alarm 1 or Alarm 2.

2.4.9 Analog Tab

This page defines how the analog inputs function and what inputs appear on the control page.

Analog inputs may also be configured to function as digital inputs. Unlike the digital inputs, the voltage levels may be configured to switch at specific voltage levels.



Figure 2.4k - Analog Tab - Analog Mode

Analog Input

Up to four analog inputs can be connected to the X-320™. This drop-down list selects the sensor to configure.

Note: If using an analog input in differential mode, only two analog inputs can be used.

Note: When Analog Input 1 is in differential mode, the settings for Analog Input 2 are disabled. When Analog Input 3 is in differential mode, the settings for Analog Input 4 are disabled.

Analog Mode

The Mode radio buttons are used to select whether the Analog Input will be used as an analog input or a digital input. The digital mode is explained in the Digital Mode section below.

Note: Both the Analog and Digital Inputs have an input range of 0-5 VDC

Description

This text field is used to describe the Analog/Digital Input. The text appears to the left of the Analog Input status on the **Control Page**. This text will also appear in email messages when email alerts are enabled. This field may be up to 9 characters long.

Units

Text in this field is used to describe the units measured by the Analog/Digital input. The text appears to the right of the analog status, and in email messages when email alerts are enabled. This field may be up to 4 characters long.

Decimal Places:

This text field is used to specify the number of digits shown on the right of the decimal point on the control page. The minimum number of decimal places shown is 0. The maximum number of decimal places shown is 5. The default for this field is 2.

Alarm 1 Color

The selected color that will be displayed on the Control Page when Alarm 1 is reached. Options are Green, Red, Yellow, Blue, Grey. The default setting is Green.

Alarm 2 Color

The selected color that will be displayed on the Control Page when Alarm 2 is reached. Options are Green, Red, Yellow, Blue, Grey. The default setting is Red.

Normal Color

This field specifies the color that will be displayed on the Control Page when the Analog Input is in a Normal condition. Options are Green, Red, Yellow, Blue, Grey. The default setting is Grey.

Differential Mode

This option determines whether or not two analog inputs will act together in differential mode or independently in single-ended mode. Differential mode can be used with sensors that have two analog outputs that are referenced to each other instead of ground.

When in differential mode, only one set of options will appear for the first input. These options will apply to the differential pair while they are in the differential mode. When two inputs are in differential mode, the first input acts as the positive input and the second input acts as the negative input.

When the inputs are in single-ended mode, each input individually acts as the positive input while the ground, AGnd, acts as the negative input.

Slope (Multiplier)

The analog inputs have an input range from 0-5 VDC. In many cases, the inputs must be scaled to represent “real-world” measurements that are outside the range of 0-5 VDC. The X-320™ reads the “raw” value from each input, and calculates the number that represents the “real-world” measurement that the user is actually interested in. This real-world value (referred to as the “scaled” value in this manual) is calculated using the following linear formula.

$$\text{Scaled Value} = \text{Slope} * \text{Input Voltage} + \text{Offset}$$

The Scaled Value is displayed on the Control Page, used to determine alarm conditions, and shown in email messages.

“Slope” in the formula above is provided by the user and is entered in this field. The value is used to scale the 0-5 VDC input to the range of detected condition. For example, a pressure sensor may have a 0.1-4.5 VDC output representing 0 to 50 psi. The multiplier would be calculated as follows.

$$50 \text{ V} / (4.5 \text{ V} - 0.1 \text{ V}) = 11.36$$

11.36 would be entered in the multiplier field.

The default value for this field is 1.

When the slope is set to 1 and offset is 0 (default values), the Scaled Value equals the Input Voltage value.

The Scaled Value is also used for the Digital Mode thresholds.

Offset

The “Offset” is used for the “zero” measurement. In the above example the offset would be set at 0.1.

The default value for this field is 0. When both the slope and offset are set to their default values, the Scaled Value equals the Raw Voltage.

Auto Calculate

The Auto Calculate process requires that precise measurements be known for two sensor positions (usually on each end of the scale). A pop-up window will appear to guide the user through the following process and provide boxes for values.

Steps for Auto Calculate:

- Once the sensor is connected, set it to the first calibration point.
- Select the Auto Calculate button and enter the “real world” value in the text box.
- Press Submit.
- Set the sensor to the second calibration point
- Enter the “real world” value into the calibration page.
- Press Submit.

Once these two points are entered, the X-320™ automatically calculates the slope and offset for that sensor.

Alarm 1

This setting is used to set the trigger point for an alarm condition. The number field specifies the value at which the alarm is triggered. The High and Low radio buttons indicate whether the alarm is triggered as a high or low alarm. A high alarm is triggered when the Scaled Value of the sensor exceeds the Alarm 1 set point. A low alarm occurs when the Scaled Value at the sensor is lower than the alarm set point.

Alarm 2

This is a second alarm trigger that works identical to Alarm 1.

Deadband

The Deadband prevents alarms from triggering excessively when the sensor measurement vacillates around the trigger point.

With high alarms, the measurement must fall below the high alarm point minus the deadband before the high alarm will be triggered again. Likewise the deadband on the low alarm requires the measurement to rise above the low alarm point plus the deadband before the low alarm will be triggered again.

For example, if the deadband is set to 0.5 V, and a high alarm occurs at 5 V, the alarm will not trigger until the temperature first drops below 4.5 V (5 V - 0.5 V).

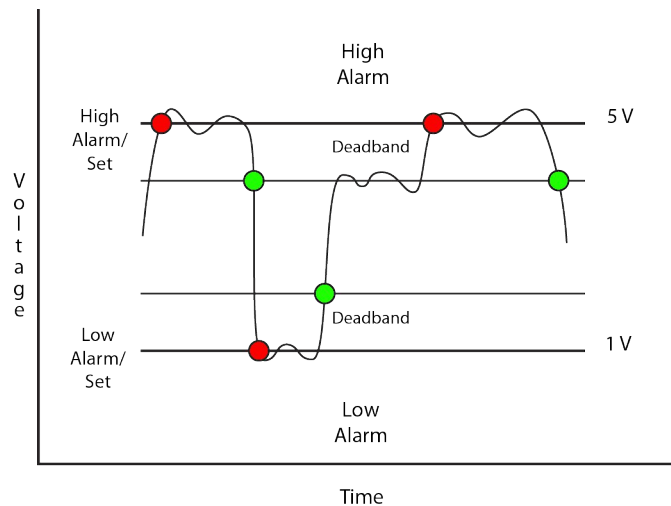

Email Option

Simple email messages can be sent in response to alarm conditions. This parameter is used to specify what alarm conditions, if any, will cause email messages to be sent. Email notification will work only if email is correctly setup in the **Network** setup page.

- **No Email Messages:** No email messages will be sent due to alarm conditions.
- **Send Email on Alarm 1:** Email notifications will be sent due to Alarm 1 conditions.
- **Send Email on Alarm 2:** Email notifications will be sent due to Alarm 2 conditions.
- **Send Email on Alarm 1 and Alarm 2:** Email notifications will be sent due to Alarm 1 or Alarm 2 conditions.
- **Send Email on Alarm 1, Alarm 2, and Normal:** Email notifications will be sent due to Alarm 1, Alarm 2, or when Normal conditions are regained.

Use Email Address

If email messages are to be sent based on alarm conditions, these check boxes specify to which email addresses the message will be sent. Email address specified on the **Network** setup tab will be shown next to each check box.

Output 1 or Output 2

This field is used to set the action that the corresponding Output will have due to an alarm condition. The first drop down box specifies the action.

Note: This option will only appear if one of the Digital I/O's is selected as an output.

The following Actions are available:

- **No Action:** No action is taken by the output.
- **Turn On:** Turns the output On due to an alarm condition. The output will turn Off when alarm conditions are no longer met
- **Turn Off:** Turns the output Off due to an alarm condition. The output will turn On when alarm conditions are no longer met.
- **Pulse:** Pulses the output for a specified amount of time due to an alarm condition.
- **Latch On:** Turns the output On due to an alarm condition. Once the output is on, it will stay On (unaffected by alarm conditions) until it is turned Off via the web by a user or the X-320™ is powered off. This option is useful for alarming functions.
- **Latch Off:** Turns Off the output due to an alarm condition. Once the output is Off, it will stay off (unaffected by alarm conditions) until it is turned on via the web by a user or the X-320™ is powered off. This option is useful for alarming functions.

The second drop down box specifies the conditions that will cause the action previously specified. The following conditions are available:

- **Alarm 1:** The specified output action occurs due to Alarm 1.
- **Alarm 2:** The specified output action occurs due to Alarm 2.
- **Alarm 1 or Alarm 2:** The specified output action occurs due to Alarm 1 or Alarm 2.

Remote Relay 1-3

The X-320™ can be configured to control relays in other ControlByWeb™ products that are located at a remote locations on the network. This field determines the action taken by Remote Relay due to an alarm condition. The following actions are available:

- **No Action:** No action is taken by the relay.
- **Turn On:** Turns the relay On due to an alarm condition. The relay will turn off when alarm conditions are no longer met.
- **Turn Off:** Turns the relay Off due to an alarm condition. The relay will turn on when alarm conditions are no longer met.
- **Pulse:** Pulses the relay for a specified amount of time due to an alarm condition.
- **Latch On:** Turn On the relay due to an alarm condition. Once the relay is On, it will stay On (unaffected by alarm conditions) until it is turned Off via the web by a user or the X-320™ is powered off. This option is useful for alarming functions.
- **Latch Off:** Turns Off the relay due to an alarm condition. Once the relay is off, it will stay Off (unaffected by alarm conditions) until it is turned on via the web by a user or the X-320™ is powered off. This option is useful for alarming functions.
- **Send Value:** Sends the scaled value to the remote unit.

The second drop down box specifies the conditions that will causes the action previously specified.

- **Alarm 1:** The specified relay action occurs due to Alarm 1.
- **Alarm 2:** The specified relay action occurs due to Alarm 2.
- **Alarm 1 or Alarm 2:** The specified relay action occurs due to Alarm 1 or Alarm 2.
- **Value Changes:** The action is applied when a new value is read from the input.

Remote Service/SNMP

This field specifies the action with a remote server due to an alarm condition.

- **No Action**: No action is taken.
- **Send State Msg/Trap**: An event string will be sent to the remote server.

The second drop down box specifies the conditions that will cause an alarm trigger. The following alarm conditions are available:

- **Alarm 1**: The specified action occurs due to Alarm 1.
- **Alarm 2**: The specified action occurs due to Alarm 2.
- **Alarm 1 or Alarm 2**: The specified action occurs due to Alarm 1 or Alarm 2.

Digital Mode

Analog inputs may function as digital inputs, with the advantage of having configurable switching levels and the ability to use Scaled Values.

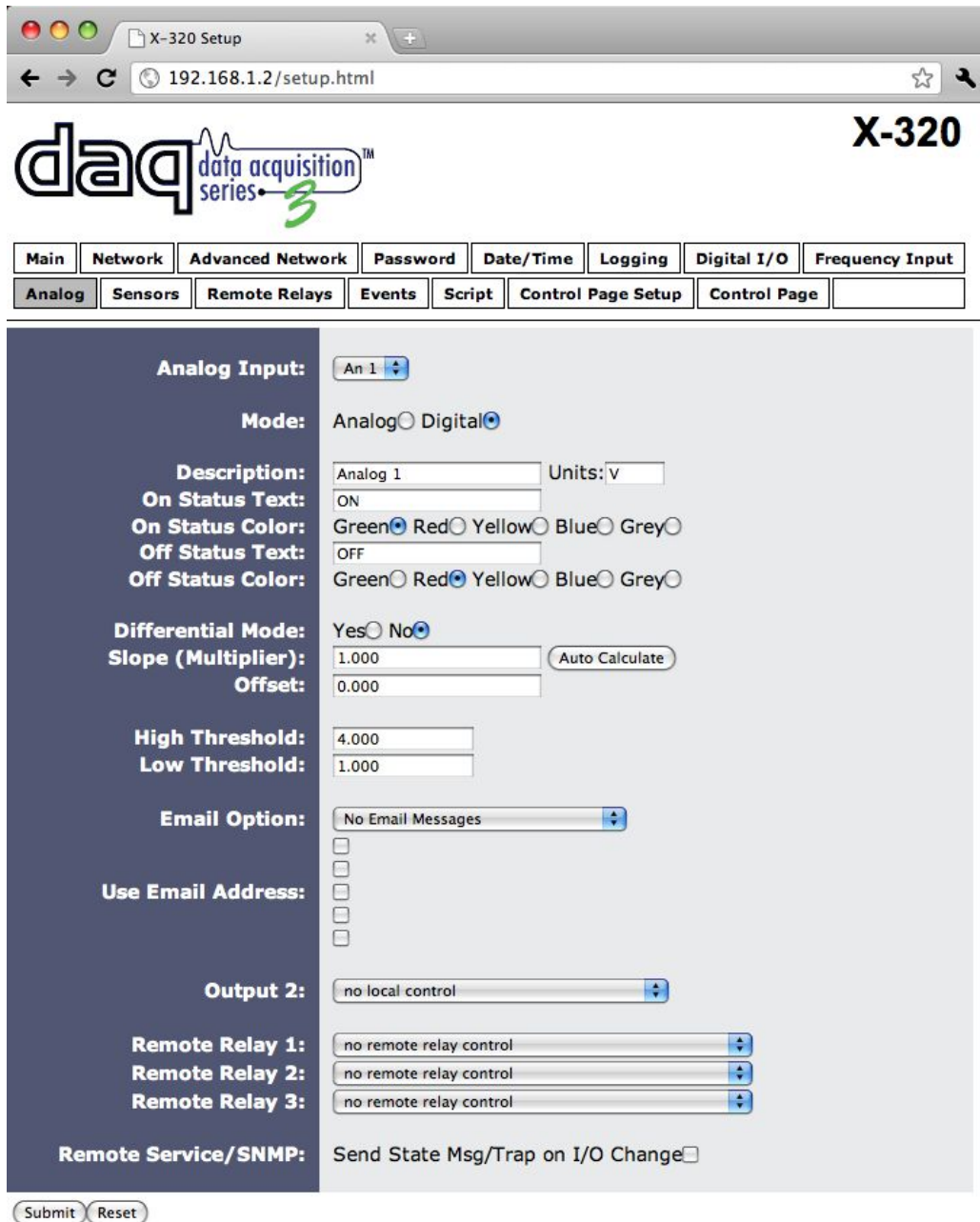

Figure 2.41 - Analog Tab - Digital Mode

Description

This text field is used to describe the Analog/Digital Input. This text appears to the left of the Analog Input status on the **Control Page**. This text will also appear in email messages when email alerts are enabled. This field may be up to 9 characters long.

Units

Text in this field is used to describe the units measured by the Analog/Digital input. The text appears to the right of the analog status, and in email messages when email alerts are enabled. This field may be up to 4 characters long.

On Status Text

The text in this field specifies the text that will be displayed in the **Control Page** and in email messages when the High Threshold is reached. Up to 15 characters may be entered in this field. The default text is ON.

On Status Color

This field specifies the color that will be displayed on the Control Page when the High Threshold is reached. Options are Green, Red, Yellow, Blue, Grey. The default color is Green.

Off Status Text

The text in this field specifies the text that will be displayed on the Control Page and in email messages when the Low Threshold is reached. Up to 15 characters may be entered in this field. The default text is OFF.

Off Status Color

This field specifies the color that will be displayed on the Control Page when the Low Threshold is reached. Options are Green, Red, Yellow, Blue, Grey. The default color is Red.

Differential Mode:

This Option determines whether or not two analog inputs will act together in differential mode or independently in single-ended mode. Differential mode can be used with sensors that have two analog outputs that are referenced to each other instead of ground.

When in differential mode, only one set of options will appear for the first input. These options will apply to the differential pair while they are in the differential mode. When two inputs are in differential mode, the first input acts as the positive input and the second input acts as the negative input.

When the inputs are in single-ended mode, each input individually acts as the positive input while the ground, AGnd, acts as the negative input.

Slope (Multiplier)

The analog inputs have an input range from 0-5 VDC. In many cases, the inputs must be converted to represent “real-world” units. The X-320™ reads the “raw” value from each input, and calculates the number that represents the “real-world” measurement. This “scaled value” is calculated using the following linear formula.

$$\text{Scaled Value} = \text{Slope} * \text{Input Voltage} + \text{Offset}$$

The scaled value is used to determine alarm conditions, displayed on the Control Page, and shown in email messages.

The “Slope” in the formula above is provided by the user and is entered in this field. The value is used to scale the 0-5 VDC input to the range of the detected condition. For example, a pressure sensor may have a 0.1-4.5 VDC output representing 0 to 50 psi. The multiplier would be calculated as follows.

$$50 \text{ V} / (4.5 \text{ V} - 0.1 \text{ V}) = 11.36$$

11.36 would be entered in the multiplier field.

When the slope is set to 1 and offset is 0 (default values), the scaled value equals the Input Voltage value.

The scaled value is for alarm thresholds, email messages, BASIC variables, SNMP and XML states, and the **Control Page** data.

Offset

The “Offset” is used for the “zero” measurement. In the above example the offset would be set at 0.1.

The default value for this field is 0. When both the slope and offset are set to their default values, the scaled value equals the Input Voltage.

Auto Calculate

The Auto Calculate process requires that precise measurements be known for two sensor positions (usually on each end of the scale). A pop-up window will appear to guide the user through the following process and provide boxes for values.

Steps for Auto Calculate:

- Once the sensor is connected, set it to the first calibration point.
- Select the Auto Calculate button and enter the “real world” value in the text box.
- Press Submit.
- Set the sensor to the second calibration point
- Enter the “real world” value into the calibration page.
- Press Submit.

Once these two points are entered, the X-320™ automatically calculates the slope and offset for that sensor.

High Threshold

This setting is used to set the trigger point for a “High” or **ON** condition for the digital input. The logic value stays high until the low threshold is crossed.

The Scaled Value, configured under the analog mode, is used as the reference for the threshold. Please see the Scale (Multiplier) and Offset sections under the Analog Mode above.

Low Threshold:

This setting is used to set the trigger point for a “Low” or **OFF** condition for the digital input. The logic value stays low until the high threshold is crossed.

The Scaled Value is used as the reference for the threshold.

Email Option

Simple email messages can be sent in response to alarm conditions. This parameter is used to specify what alarm conditions, if any, will cause email messages to be sent. Email notifications will work only if email is correctly setup in the **Network** setup page.

- **No Email Messages:** No email messages will be sent due to alarm conditions.
- **Send Email on Alarm 1:** Email notifications will be sent due to Alarm 1 conditions.
- **Send Email on Alarm 2:** Email notifications will be sent due to Alarm 2 conditions.
- **Send Email on Alarm 1 and Alarm 2:** Email notifications will be sent due to Alarm 1 or Alarm 2 conditions.
- **Send Email on Alarm 1, Alarm 2, and Normal:** Email notifications will be sent due to Alarm 1, Alarm 2, or when Normal conditions are regained.

Use Email Address

If email messages are to be sent out based on alarm conditions, these check boxes specify to which email addresses the message will be sent. Email address specified on the **Network** setup tab will be shown next to each check box.

Output

This field is used to set the action that the corresponding Output will have due to an alarm condition. The first drop down box specifies the action. The following Actions are available:

- **No Action:** No action is taken by the output.
- **Turn On:** Turns the output On due to an alarm condition. The output will turn Off when alarm conditions are no longer met
- **Turn Off:** Turns the output Off due to an alarm condition. The output will turn On when alarm conditions are no longer met.
- **Pulse:** Pulses the output for a specified amount of time due to an alarm condition.
- **Latch On:** Turns the output On due to an alarm condition. Once the output is on, it will stay On (unaffected by alarm conditions) until it is turned off via the web by a user or the X-320™ is powered off. This option is useful for alarming functions.
- **Latch Off:** Turns Off the output due to an alarm condition. Once the output is Off, it will stay Off (unaffected by alarm conditions) until it is turned on via the web by a user or the X-320™ is powered off. This option is useful for alarming functions.

The second drop down box specifies the conditions that will cause the action previously specified. The following conditions are available:

- **Alarm 1:** The specified output action occurs due to Alarm 1.
- **Alarm 2:** The specified output action occurs due to Alarm 2.
- **Alarm 1 or Alarm 2:** The specified output action occurs due to Alarm 1 or Alarm 2.

Remote Relay 1-3 Option

When in digital input mode, analog inputs can be configured to control relays on other ControlByWeb™ products at a remote locations. The Remote Relay Option drop-down settings are used to specify remote relay actions.

The options in the drop down list are described below.

Note: Input changes will only affect the output or remote relay at the time the input is changed. Once the change has taken place, the state of the input has no effect on the state of the output or remote relay. In other words, if an input causes the remote relay to go on, a user may turn the remote relay off from the web browser, even if the local input is still on.

- **no remote relay control:** The input has no effect on the remote relay.
- **remote command equals input:** When the input is considered On, a command is sent to the remote relay to set the relay state to on. When the input is considered Off, a command is sent to the remote relay to set the relay state to off.
- **remote command opposite of input:** When the input is considered Off, a command is sent to the remote relay to set the relay state to On. When the input is considered On, a command is sent to the remote relay to set the relay state to Off.
- **send on command when input on (no off command):** When the input is considered On, a command is sent to the remote relay to set the relay state to On. When the input is considered Off, no commands are sent to the remote relay.
- **send on command when input off (no off command):** When the input is considered Off, a command is sent to the remote relay to set the relay state to on. When the input is considered On, no commands are sent to the remote relay.
- **send off command when input off (no on command):** When the input is considered Off, a command is sent to the remote relay to set the relay state to Off. When the input is considered On, no commands are sent to the remote relay.
- **send off command when input on (no on command):** When the input is considered On, a command is sent to the remote relay to set the relay state to Off. When the input is considered Off, no commands are sent to the remote relay.
- **send pulse command when input on:** When the input is considered On, a command is sent to the remote relay to Pulse the relay. When the input is considered Off, no commands are sent.
- **send pulse command when input off:** When the input is considered Off, a command is sent to the remote relay to pulse the relay. When the input is considered On, no commands are sent.
- **send pulse command when input changes:** When the input is considered On, or Off, a command is sent to the remote relay to pulse the relay.
- **send toggle command when input on:** When the input is considered On, a command is sent to the remote relay to toggle the relay (change the remote relay to the state opposite of its current state). When the input is considered Off, no commands are sent.
- **send toggle command when input off:** When the input is considered Off, a command is sent to the remote relay to toggle the relay (change the remote relay state to the state opposite of its current state). When the input is considered On, no commands are sent.
- **send toggle command when input changes:** When the input is considered On or Off, a command is sent to the remote relay to toggle the relay (change the remote relay to the state opposite of its current state).
- **remote relay equals input (heartbeat mode):** This is used for a “fail-safe” alarm configuration. This configuration is described as “fail-safe”, because it can be used to trigger an alarm if network or other equipment fails. This setting is used with a remote relay that controls the alarm. The alarm would be wired using the normally-closed contacts, so as long as the relay is *ON*, the alarm will remain *OFF*. Under normal conditions, the relay stays *ON* because the X-320™ sends periodic pulse messages that keep the relay turned *ON*. If an alarm condition occurs, the X-320™ will send a message to the remote relay unit to turn *OFF* the relay and sound the alarm. If there is an equipment failure (for example, the network switch failed), the remote relay will stop receiving the pulse messages. As soon as the pulse timer in the remote relay expires the remote relay turns *OFF* its relay and the alarm will sound. This can also be used with normally open contacts to ensure that a remote device doesn't remain on in case of a network failure.

When the option **remote command equals input (heartbeat mode)** is selected, Periodic State Interval must be set in the **Remote Relay Tab**. A range of 5-50 seconds can be used. Set the Periodic State Interval to just under half the pulse time specified in the remote relay. This configuration will cause the X-320™ to send a message to the remote relay at the interval rate specified by the Periodic State Interval. When the input is considered On, it will send pulse commands. When the input is considered off, it will send off commands. In addition to sending commands at the specified interval, commands will be sent each time the input changes state.

Remote Service/SNMP

When this box (Send State Msg/Trap on Input Change) is checked, SNMP traps and/or State messages will be sent whenever the input state changes.

2.4.10 Sensor Tab

This tab is used to configure temperature/humidity sensors and associated alarms. X-320™ will automatically detect whether a temperature or humidity sensor is connected.

Sensor

Up to six sensors can be connected to X-320™. This drop-down list selects the sensor to be configured. The fields below are the same for each sensor.

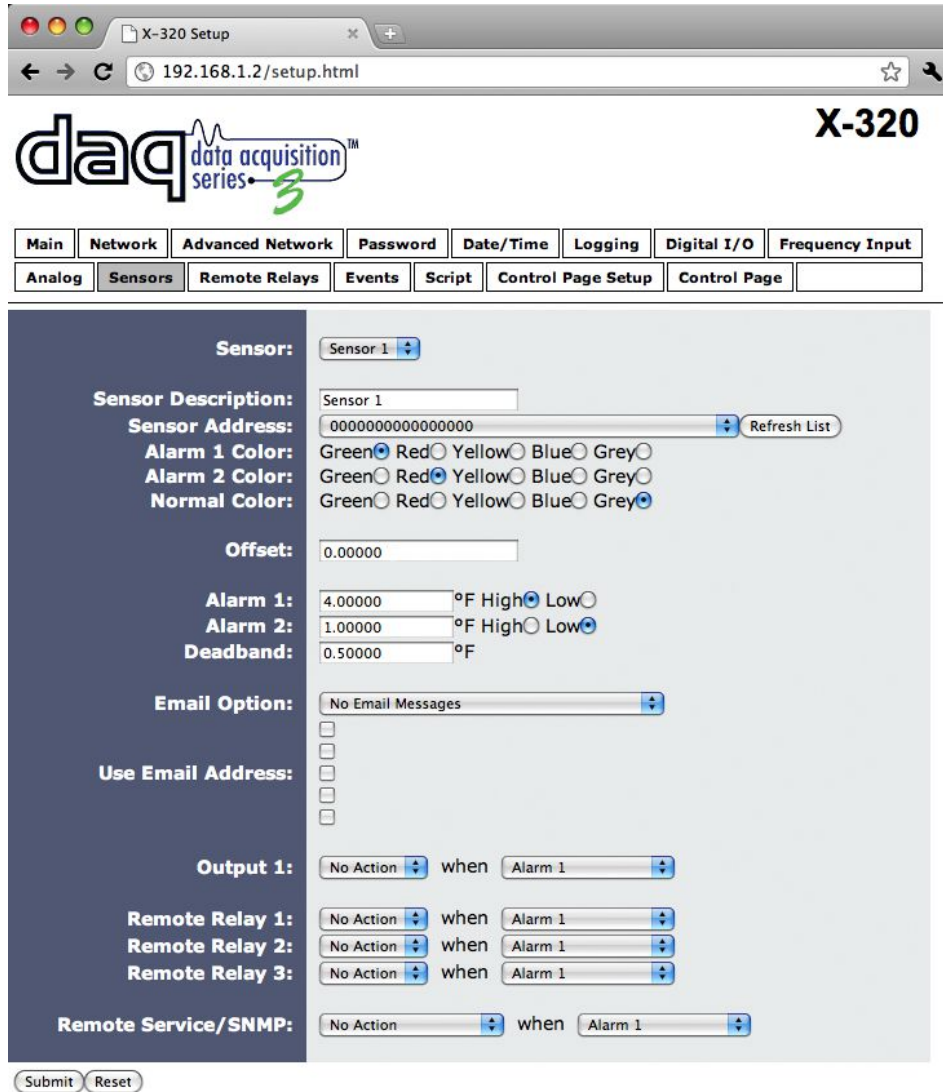

Figure 2.4m - Sensors Tab

Sensor Description

The text in this field appears to the left of the corresponding temperature/humidity reading on the Control Page. This text also appears in the email status message when email is enabled. This field can be up to 24 characters in length. The default text in this field is Sensor #.

Sensor Address

Each sensor connected to X-320™ should be associated (or assigned) to a sensor number. This identifies the name, location, and function of the sensor. Every temperature/humidity sensor comes from the factory with a unique, non-changeable address. When the sensors tab is selected (or the Refresh List button is pressed), X-320™ scans the bus for sensors. The addresses of the sensors that are found on the bus are listed in the drop-down list. For each sensor number (Sensor 1... Sensor 3), select the address of the appropriate sensor from the drop-down list.

Selecting sensors is simplest when the sensors are connected to the bus one at a time. The procedure is to start with one sensor and associate it with the appropriate sensor number by selecting the sensor address within the appropriate drop-down list. Submit the page, connect a second sensor, and press the Refresh List button. Associate the second sensor to the appropriate sensor number. Continue this procedure until all sensors are set up.

Alarm 1 Color

This field specifies the color that will be displayed on the Control Page when Alarm 1 is reached. Options are Green, Red, Yellow, Blue, Grey. The default color is Green.

Alarm 2 Color

This field specifies the color that will be displayed on the Control Page when Alarm 2 is reached. Options are Green, Red, Yellow, Blue, Grey. The default color is Red.

Normal Color

This field specifies the color that will be displayed on the Control Page when the sensor is in a Normal condition. Options are Green, Red, Yellow, Blue, Grey. The default color is Grey.

Offset

The value of the offset will be added to the sensor's reading. Normally this should be set to zero.

Alarm 1

This setting is used to set the trigger point for an alarm condition. The number field specifies the temperature/humidity at which the alarm is triggered. The "High" and "Low" radio buttons indicate whether the alarm is triggered as a high or low alarm. A high alarm is triggered when the sensor reading exceeds the alarm value, and a low alarm is occurs when the sensor reading falls below the alarm value.

Alarm 2

This is a second alarm trigger that works similar to Alarm 1.

Deadband

The Deadband prevents alarms from triggering excessively when the sensor measurement vacillates around the trigger point.

With high alarms, the measurement must fall below the high alarm point minus the deadband before the high alarm will be triggered again. Likewise the deadband on the low alarm requires the measurement to rise above the low alarm point plus the deadband before the low alarm will be triggered again.

For example, if the deadband is set to 1 degree, and a high alarm is occurs at 95 degrees, the dead band ensures that once the high alarm is triggered, it won't trigger again until the temperature first drops below 94 degrees (95 – 1).

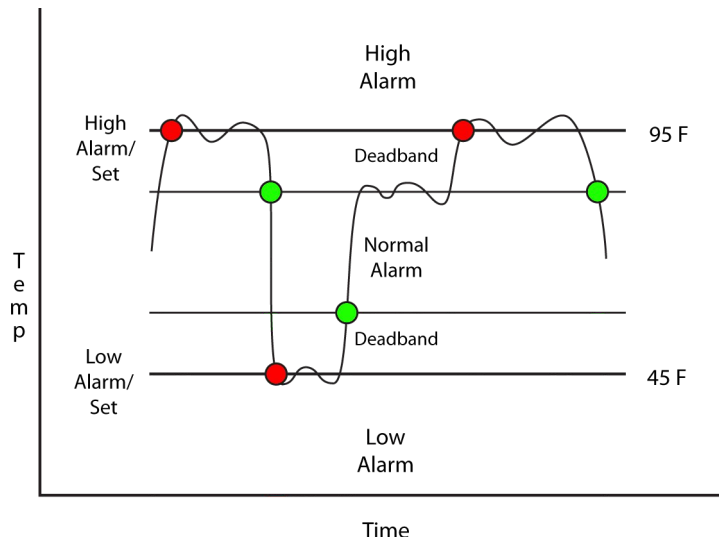

Figure 2.4n - Alarm Deadband

Email Option

Simple email messages can be sent in response to alarm conditions. This parameter is used to specify what alarm conditions, if any, will cause email messages to be sent. Note that email notification will work only if email is correctly setup in the **Network** setup page.

- **No Email Messages:** No email messages will be sent due to alarm conditions.
- **Send Email on Alarm 1:** Email notifications will be sent due to Alarm 1 conditions.
- **Send Email on Alarm 2:** Email notifications will be sent due to Alarm 2 conditions.
- **Send Email on Alarm 1 and Alarm 2:** Email notifications will be sent due to Alarm 1 or Alarm 2 conditions.
- **Send Email on Alarm 1, Alarm 2, and Normal:** Email notifications will be sent due to Alarm 1, Alarm 2, or when normal conditions are regained.

Use Email Address

If email messages are to be sent out based on alarm conditions, these check boxes specify to which email addresses the message will be sent. Email address specified on the **Network** setup tab will be shown next to each check box.

Remote Relay 1-3

The X-320™ can be configured to control relays in other ControlByWeb™ products that are located at a remote location on the network. The same actions for the local outputs also apply to remotely controlled relays. This field determines the action taken by Remote Relay due to an alarm condition. The following actions are available:

- **No Action:** No action is taken by the relay.
- **Turn On:** Turns the relay On due to an alarm condition. The relay will turn Off when alarm conditions are no longer met.
- **Turn Off:** Turns the relay Off due to an alarm condition. The relay will turn On when alarm conditions are no longer met.
- **Pulse:** Pulses the relay for a specified amount of time due to an alarm condition.
- **Latch On:** Turns On the relay due to an alarm condition. Once the relay is On, it will stay On (unaffected by alarm conditions) until it is turned Off via the web by a user or the X-320™ is powered off. This option is useful for alarming functions.
- **Latch Off:** Turns Off the relay due to an alarm condition. Once the relay is Off, it will stay Off (unaffected by alarm conditions) until it is turned on via the web by a user or the X-320™ is powered off. This option is useful for alarming functions.

The second drop down box specifies the conditions that will causes the action previously specified.

- **Alarm 1:** The specified relay action occurs due to Alarm 1.
- **Alarm 2:** The specified relay action occurs due to Alarm 2.
- **Alarm 1 or Alarm 2:** The specified relay action occurs due to Alarm 1 or Alarm 2.

Remote Service/SNMP

This field specifies the action with a remote server due to an alarm condition.

- **No Action:** No action is taken.
- **Send State Msg/Trap:** An event string will be sent to the remote server.

The second drop down box specifies the conditions that will cause an alarm trigger. The following alarm conditions are available:

- **Alarm 1:** The specified action occurs due to Alarm 1.
- **Alarm 2:** The specified action occurs due to Alarm 2.
- **Alarm 1 or Alarm 2:** The specified action occurs due to Alarm 1 or Alarm 2.

2.4.11 Remote Relays Tab

Figure 2.4o - Remote Relays Tab

Remote Relay

This option allows you to select which remote relay the following settings will apply

IP Address

The IP address of the remote relay is entered here. The default value is 192.168.1.15

TCP Port

The TCP port number used to access the remote relay is entered here. This must match the TCP port (HTTP port) set in the remote relay. The valid range is 0 to 65530. The default port number is 80

Password

If the remote relay requires a password for control, the password must be entered here

Relay #

The remote relay device may have multiple relays. This field is used to identify the specific relay to be controlled on the remote device. If the remote device is a single WebRelay™, this field should be zero. If the remote device has multiple relays, this field should be set to the relay number. For example if relay 2 is to be controlled on another ControlByWeb™ product, the Relay # would be set to 2. This field may be set from 0 to 255.

Periodic State Interval

When the X-320™ is configured to control a remote device, a connection is established. If the device does not receive a message for 50 seconds the connection is terminated. In order for the connection to be maintained, a message containing the state of the relay can be sent at a periodic interval. This field sets the time interval at which the message is sent. The default setting is 50 seconds, thus just maintaining the connection. If the connections should not be maintained enter a value of 0. This field may be set to 0 or 5-50 seconds.

2.4.12 Events Scheduler Tab

Events can be programmed to turn the Outputs **ON** and **OFF** at specific times. Up to 100 events can be created. Each event can occur one time or multiple times.

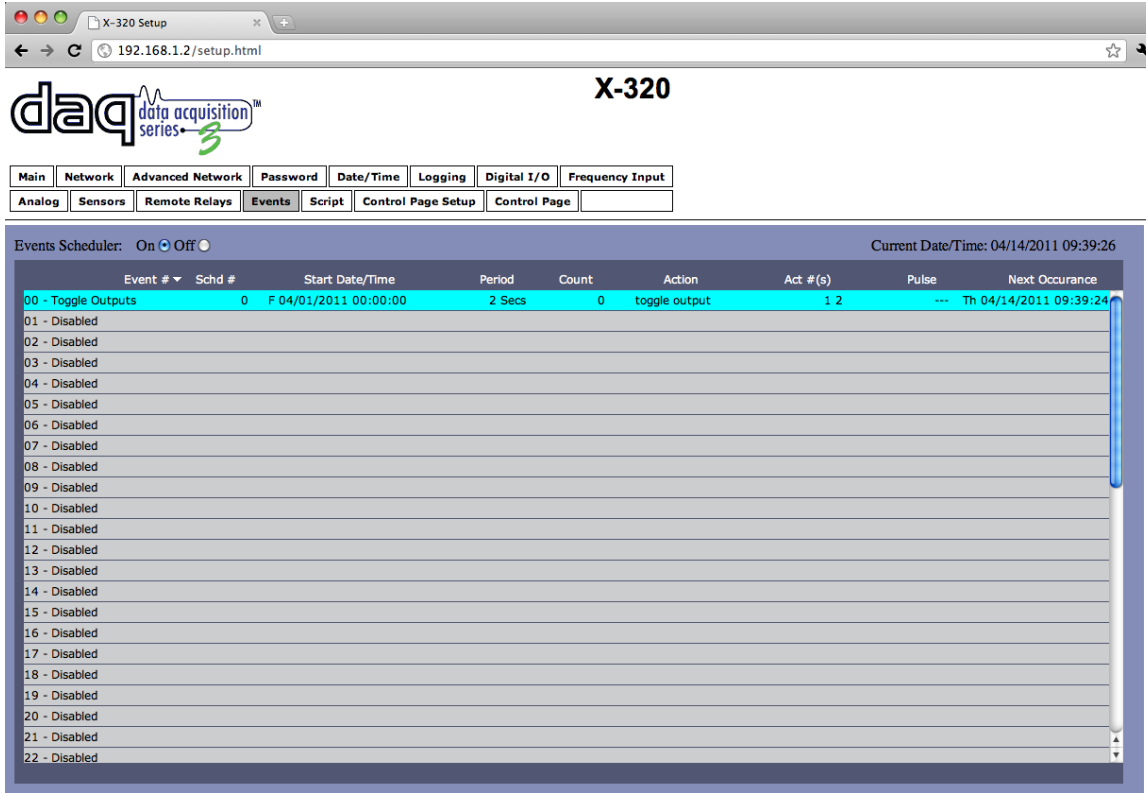

Figure 2.4p - Events Tab

A list of all scheduled events and information about each event is displayed in a table. Events can be sorted according to each column, in ascending or descending order. The following columns are displayed.

- **Events Scheduler: On/Off:** Turns scheduled events **ON** or **OFF**. **ON** is selected by default.
- **Current Date/Time:** Displays the current date and time.
- **Event #:** The number and name of events that are listed.
- **Sched #:** The schedule where the event is located (0 is the default schedule).
- **Start Date/Time:** The start date and time (24-hour) of the event.
- **Period:** The time between the start of successive events.
- **Count:** The number of times the event will occur.
- **Action:** What action the outputs or schedule will take
- **Act #(s):** Which of the outputs or schedules, if any, will be affected by the event.
- **Pulse:** If an output pulse event is programmed, the Pulse Duration will be displayed.
- **Next Occurrence:** The date and time of the event's next occurrence will be displayed. If the event has already occurred, the event will be listed as "Inactive" here.

The events are color coded to indicate their status.

- **Gray** – Event has not been set up.
- **Green** – Events are active and will occur sometime in the future.
- **Red** – Events have been temporarily disabled by the disable event action.
- **Yellow** – Events have already occurred and are not scheduled to happen in the future.

Configuration of events is accomplished by clicking on the appropriate event, which causes the following setup screen to be displayed.

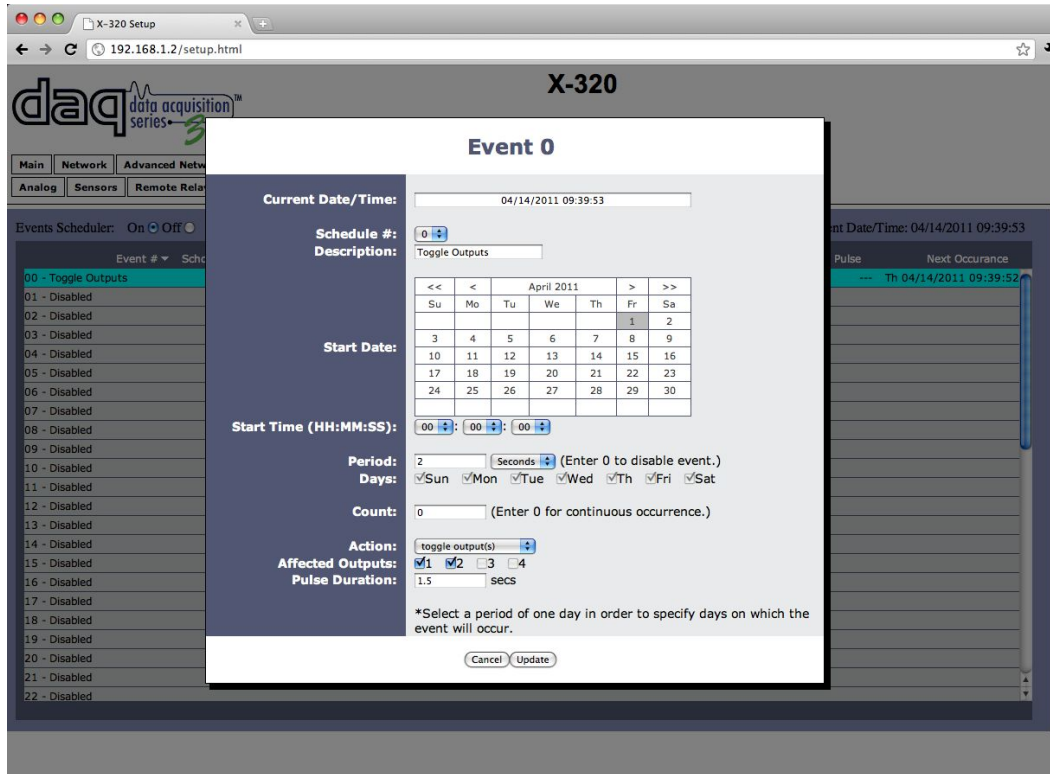

Figure 2.4q - Event Setup

Current Date/Time

This field displays the current date and time as specified in the **Date/Time** tab.

Schedule

X-320™ can be setup to use multiple schedules. The master event schedule is schedule 0. (See **Schedules** for more information.)

Description

Text entered here is used to name and describe each event. The default text is `Event Description`.

Start Date

This field is used to enter the start date of the event. The date is entered by first selecting the correct month and year by using the left and right arrows at the top of the calendar. The single arrows (< and >) change the month and the double arrows (<< and >>) change the year. Once the current month and year are displayed, the date should be entered by selecting the day.

Start Time (HH:MM:SS)

The start time of the event is entered in the drop down menus as HH:MM:SS (HH represents hours in 24-hour format [00-23], MM represents minutes [00-59], SS represents seconds [00-59]). Default setting is 00:00:00.

Period

When events are configured to occur more than one time (any entry other than 1 in the Count below), the period field specifies the time between the beginning of events. This time can be specified in **Seconds**, **Minutes**, **Hours**, **Days**, or **Weeks** by selecting the appropriate option in the drop down menu. Default settings is 0 Days. Note that selecting 0 will disable the event.

Days

When a **Period** of one day is selected, the day (or days) on which that event will occur can be specified by marking the appropriate check boxes.

Count

The number of times the event will occur is specified. The default text is 0. Note that entering 0 in this field will cause the event to occur continuously.

Action

This drop down menu specifies which action will take place when the event occurs. The following options may be selected

- **no action**: When this option is selected, nothing will happen when event occurs.
- **turn output(s) on**: This option causes the output(s) specified in the Affected Output(s) field to turn **ON** when event occurs.
- **turn output(s) off**: This option causes the output(s) specified in the Affected Output(s) field to turn **OFF** when event occurs.
- **pulse output(s)**: This option causes the output(s) specified in the Affected Output(s) field to turn **ON** when the event occurs, and then turn **OFF** after the Pulse Duration time (specified below) expires.
- **toggle output(s)**: This option causes the output(s) specified in the Affected Output(s) field to change states.
- **change schedules**: This option causes the schedule(s) specified in the Affected field to be enabled or disabled. (See **Schedules** at the end of this section for more information).
- **set extVar0**: External variables provide a way for scripts written in BASIC to interact with users, and for scripts to execute as a result of event occurrences. This option sets the variable extvar0 to 1 when the event occurs. If a running script uses this variable, it will function as defined in the script when the variable is set to 1.
- **clear extVar0**: This option clears extvar0 (sets it to 0) when the event occurs. See description of set extVar for more information.

Affected Output(s)

When an Action is selected, the **Affected Output(s)** on which that action will occur can be specified by marking the appropriate check boxes. When change schedules is selected, check boxes 1-4 are selectable.

Pulse Duration

If the Output Action has been set to **pulse output(s)**, the **Pulse Duration** is set in this field. The time is specified in seconds and can range from 0.1 seconds to 86400 seconds in 0.1 second increments. The default time is 1.5 seconds.

Schedules

Events can be assigned to one of five schedules. The schedules are useful for creating complex events that vary with calendar dates, such as work shift alarms.

Schedule 0 is always active, it cannot be disabled. Other schedules can be enabled and disabled by schedule events. Multiple schedules may be active at one time. The following is an example of how schedules and events might be used.

Schedule 0 Event – Communication device is enabled daily at 8 pm and disabled at 6 am, Monday through Friday. (The web interface could be used to disable the system for any authorized exceptions.)

Field Name	Event 1	Event 2	Application Description
Schedule #	0	0	Schedule 0 cannot be disabled by other events.
Description	SCADA ON	SCADA OFF	User description of event.
Start Date	Current Day	Current Day	Set to current or previous day.
Start Time	20:00:00	06:00:00	Start time in 24 hr format.
Period	1 Days	1 Days	Event occurs daily.
Days	M-F	M-F	Security system is disabled during work hours and remains on over weekend.
Count	0	0	Event is always in effect, set to zero.
Action	turn output on	turn output off	Security system is controlled through Output 1.
Affected	1	1	Output 1 receives the Action
Pulse Duration	n/a	n/a	The value is ignored except for a pulse action.

Schedule 1 and 2 Events – Radio transmission reports triggered at 8 am and 5 pm Monday through Friday, during winter months but, shifts to 6 am start time during summer.

Field Name	Event 3	Event 4	Event 5	Event 6	Event 7	Event 8
Schedule #	1	1	1	2	2	2
Description	Summer AM Report	Summer AM Report	End Summer	Winter AM Report	Winter AM Report	End Winter
Start Date	30 May	30 May	01 Sep	01 Sep	1 Sep	30 May
Start Time	08:00:00	17:00:00	00:00:00	06:00:00	03:00:00	00:00:00
Period	1 Days	1 Days	1 Days	1 Days	1 Days	1 Days
Days	M-F	M-F	All	M-F	M-F	All
Count	0	0	0	0	0	0
Action	pulse output	pulse output	change schedules	pulse output	pulse output	change schedules
Affected	1	1	2	1	1	1
Pulse Duration	3	3	n/a	3	3	n/a

In the above example, the Affected row applies to Outputs when an output action is selected, or schedules when a change schedule action is selected.

The security system example could also be changed to schedules 1 and 2, allowing for different hours of operation for summer and winter schedules. Additional lunch or break bells could also be added to schedules 1 and 2 or added in schedules 3 and 4. Events 5 and 8 enable and disable schedules. Event 5 would enable schedule 2, and disable schedules 1,3,4. Event 8 would enable schedule 1, and disable schedules 2,3,4.

Additional equipment could be controlled by event schedules such as lighting, compressors, and magnetic door locks.

2.4.13 Script Tab

X-320™ can be used to run simple custom programs written in a language similar to BASIC. This page is used to load and execute these programs. Before it can be loaded to X-320™, a script must first be written as a .txt file. The file must then be uploaded to X-320™. The maximum size of script that can be uploaded to the device is 2K bytes. Information on writing a basic program for X-320™ can be found in **Appendix G: Basic Scripts**.

Note: An ASCII standard text file format should be used, such as Windows Notepad, Programmer's Notepad, vi, or other text editor that output the file as a .txt. Rich Text Format (.rtf) used by Microsoft WordPad is NOT compatible.

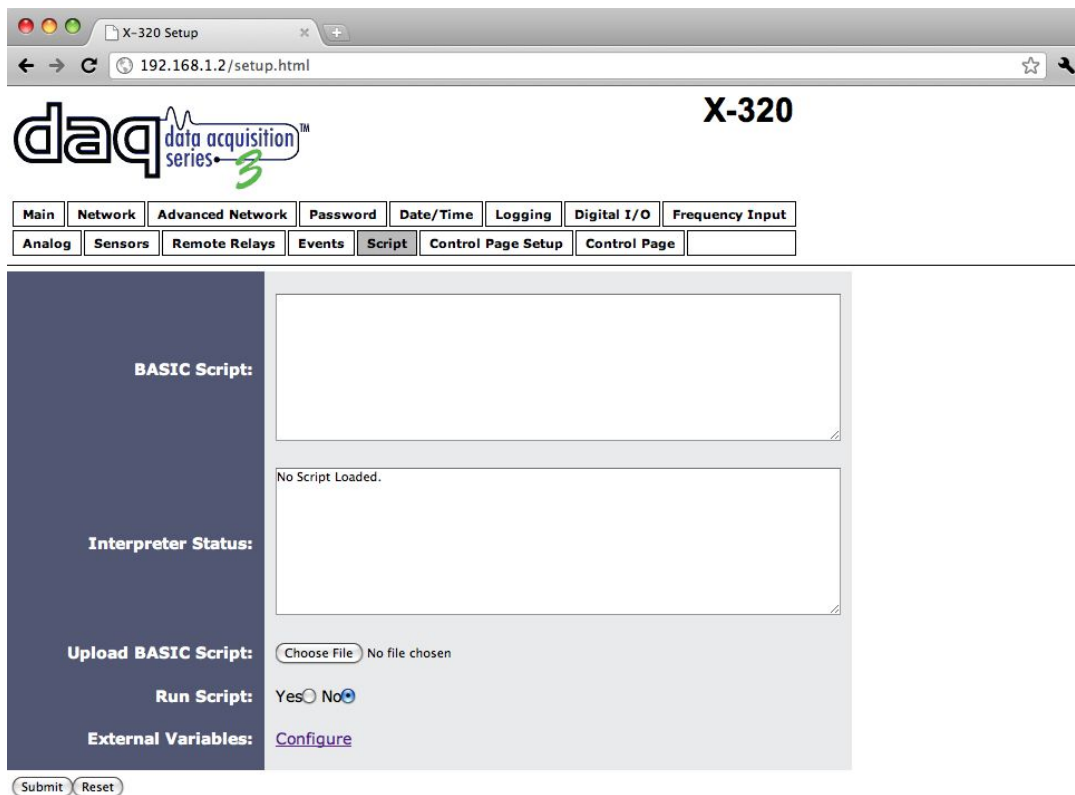

Figure 2.4r - Script Tab

BASIC Script

This field displays the .txt file that is uploaded to X-320™. Text displayed in this screen cannot be edited. In order to edit any script, it must be rewritten in the .txt file and uploaded to the unit again.

Interpreter Status

This field displays whether the program is continuing to run, has stopped or finished, or if there are errors contained in the script. If there are errors in the script, the line on which the error occurred is displayed.

Upload BASIC Script

This field displays the script selected to be uploaded to the device. To upload a script to X-320™, click the 'Choose File' button, find the .txt file previously written, and select 'Open.' The location of the file should appear in the neighboring field. To upload the script to the unit, select 'Submit.'

Run Script

This option selects whether or not the selected script will be run after it has been uploaded. The Submit button must be clicked to run the script.

External Variables

External Variables are variables that can be used in BASIC scripts. They are called External Variables because their values can be changed externally to the BASIC script using XML requests, or through the **Control Page**. This allows basic scripts to react to user input. These variables are considered to be floating point numbers, just like other variables in the BASIC script.

The following page is displayed when configuring External Variables:

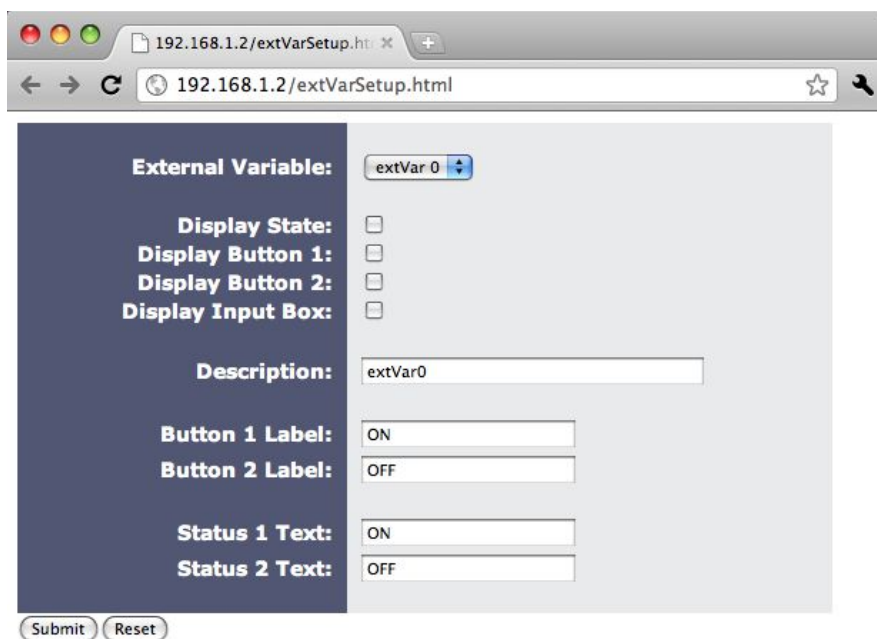

Figure 2.4s - ExtVar Configuration

External Variable

This drop down menu offers the option to configure each of the four External Variables.

Display State

Checking this box will display the state of the selected External Variable on the **Control Page**.

Display Button 1

Checking this box will display a button on the **Control Page**. Clicking this button on the **Control Page** will set the extVar to 1.

Display Button 2

Checking this box will display a button on the **Control Page**. Clicking this button will clear the extVar to value 0.

Display Input Box

Checking this box will display an input box on the **Control Page**. Entering a value on the **Control Page** in this field and clicking Set, will set the selected extVar to the new value. Values entered can be either positive or negative numbers.

Description

Text entered here will be displayed in the left column of the control page. Up to 14 characters may be entered here. The default text is `extVar#`.

Button 1 Label

This text field is used to describe the function of button 1 of the selected extVar. The text also appears to the right of the corresponding extVar status. Up to 9 characters may be entered here. By default, this text is `ON`.

Button 2 Label

This text field is used to describe the function of button 2 of the selected extVar. The text also appears to the right of the corresponding extVar status. Up to 9 characters may be entered here. By default, this text is `OFF`.

Status 1 Text

The text in this field specifies the text that will be displayed when the extVar is value 1, with a gray background. The text also appears in the status column on the **Control Page**. Up to 9 characters may be entered here. By default the text is `ON`.

Status 2 Text

The text in this field specifies the text that will be displayed when the extVar is value 0, with a gray background. The text also appears in the status column on the **Control Page**.

If the extVar is any other value than 1 or 0, the value will be displayed in the same column, with a gray background. Up to 9 characters may be entered here. By default the text is `OFF`.

2.4.14 Control Page Setup Tab

The **Control Page Setup** page is used mainly to set parameters that affect the view of the **Control Page**, how often it will refresh, etc.

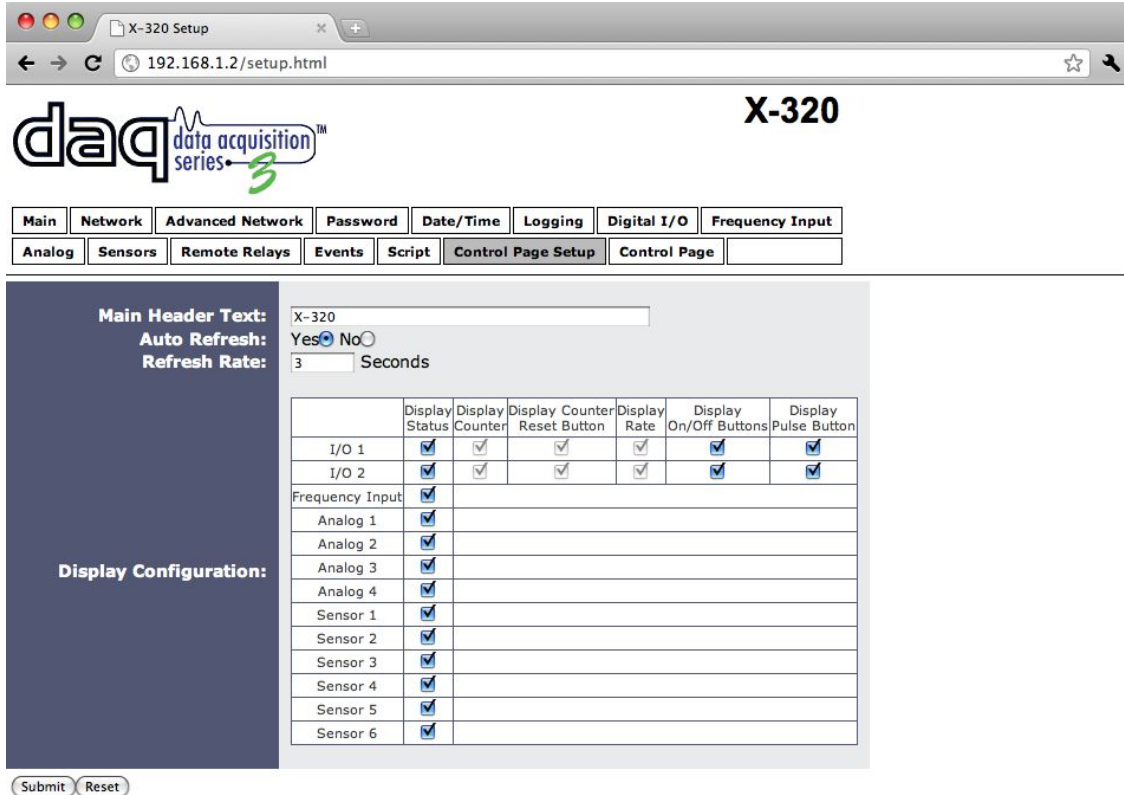

Figure 2.4t - Control Page Setup Tab

Main Header Text

The text entered here appears at the top of the **Control Page**. It also appears in the header of the email text when the email notification is used. This field can be up to 40 characters in length. The default text is X-320.

Auto Refresh

The Auto Refresh Page option will cause the **Control Page** to continually update its contents by setting a timer in the web page that causes it to be reloaded at a specified time interval. When set to **Yes**, the web page will be refreshed at the time interval specified in the Refresh Rate setting. When set to **No**, the web page will need to be manually refreshed to show the current status of the unit on the control page.

Refresh Rate

When the Auto Refresh Page option is set to **Yes**, this field specifies the time interval in seconds that the page will be refreshed. It can be set from 1 to 32 seconds. The default Refresh Rate is 3 seconds

Display Configuration

This field sets the options that are displayed on the **Control Page**. Only boxes that are applicable to the input or output state are active. For example, Display Rate is grayed when the I/O is set as an input.

- **Display State:** For I/O 1 and 2, Frequency Input, Analog 1-4, and Sensors 1-6, this controls whether the current state is displayed
- **Display Counter:** When checked, the counter is displayed for the selected input.
- **Display Counter Reset Button:** When checked, a Reset button is displayed to reset the counter on the selected input.
- **Display Rate:** Shows the rate of the digital input state changes, a digital frequency counter.
- **Display On/Off Buttons:** When checked, an On and Off button is displayed for direct user control.
- **Display Pulse Button:** When checked, a button allowing a user to manually pulse a specified output is displayed.

Section 3: Operation

X-320™ can be operated using a web browser, by sending text commands to an XML status/control page, and/or by sending Modbus/TCP requests. X-320™ also allows you to control the outputs using inputs, or events. (Using an input or event to control the outputs was described throughout previous sections of the manual, and will not be described here.)

3.1 Browser Operation

Once X-320™ is set up, users can access the Control Page using a web browser by typing the IP address of X-320™ into the web browser address bar. For example, using the default IP address, the user would enter `http://192.168.1.2`. If the IP address is changed from the default, the user must use the new IP address. Note that if any port is used other than the default port 80, the port must also be included in the request. For example, accessing the unit at port 8000 would be as follows: `http://192.168.1.2:8000`.

The following screen appears when the Control Page is Selected:

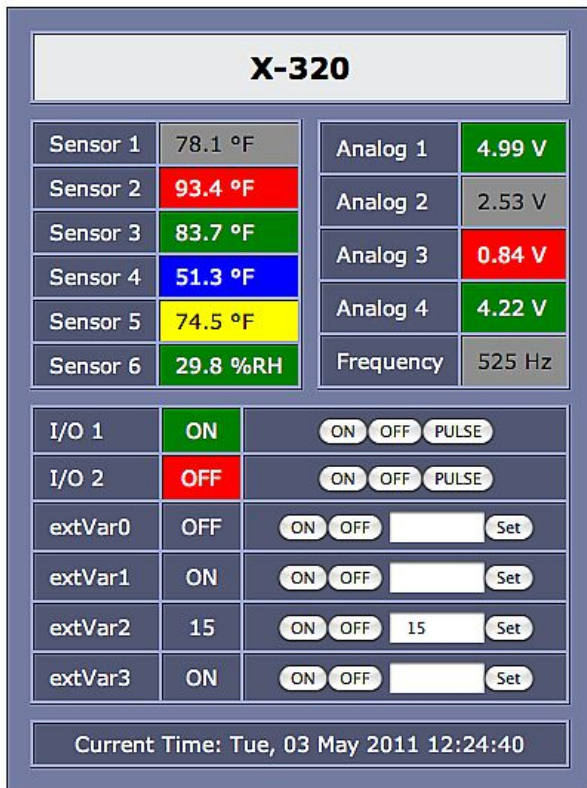

Figure 3.1a - Control Page - I/O Configured as Output
Analog Configured as Analog | ExtVars displayed

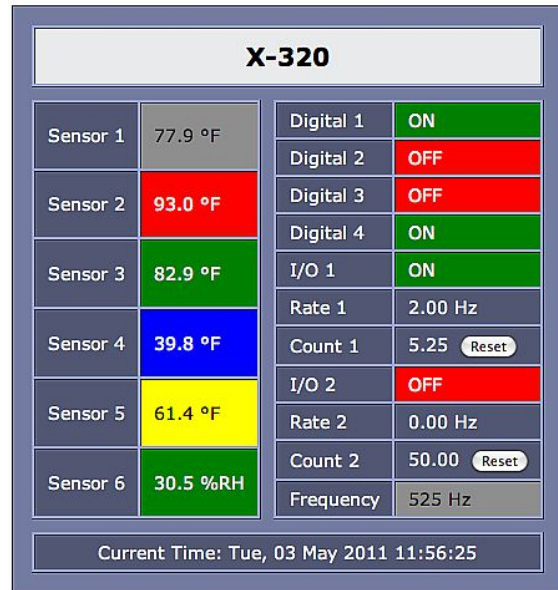

Figure 3.1b - Control Page - I/O Configured as Input | Analog Configured as Digital

Header

Displays the text entered in the Main Header Text field on the **Control Page Setup** tab in the setup pages.

Sensor 1-6

These rows display the current temperature or humidity measured by the associated sensors. Each row can be displayed (as shown) or not displayed by checking or clearing the appropriate boxes under the **Control Page Setup** tab in the setup pages. The text in the left column (by default reads Sensor 1 through Sensor 6), is specified in the Sensor Description field under the **Sensors** tab in the setup pages.

Digital I/O 1-2

These rows display the current state of the two I/Os. When the I/O is selected for an output, it will be shown as in figure 3.1a. These rows can be displayed (as shown) or not displayed by checking or clearing the appropriate boxes in the **Control Page Setup** tab in the setup pages. The text in the left column (by default reads I/O 1 and I/O 2) is specified in the Description field under the **I/O** tab in the setup pages. The state of the I/O is shown to the right of the description text. By default, the status text will read **ON** or **OFF**; however, the status text can be changed in the **I/O** tab. To the right of the output status, buttons are provided to control the output (On, Off, Pulse).

When the I/O is selected as an Input, it will be shown as in figure 3.1b. These rows can be displayed (as shown) or not displayed by checking or clearing the appropriate boxes in the **Control Page Setup** tab. The text in the left column (by default reads I/O 1 and I/O 2) is specified in the Description field under the **I/O** tab in the setup pages. The state of the I/O is shown to the right of the description text. Below the description and state, the rate description and value is displayed. Below the rate, the Input counter is displayed, along with its description and value. To the right of the counter value, a reset button can be displayed by checking the appropriate box in the **Control Page Setup** tab.

Rate 1-2

The averaged rate of change of the digital inputs may be displayed on the Control Page by setting or clearing the Rate checkbox.

Count 1-2

A cumulative count of OFF to ON states of the digital inputs is displayed when the I/O is configured as an input and the Display Counter box is checked. A reset button may also be displayed on the **Control Page**.

Analog 1-4

These rows display the current Scaled Analog Value of the four Analog Inputs. Each of these rows can be displayed (as shown) or not displayed by checking or clearing the appropriate boxes on the Control Page Setup tab in the setup pages. The text in the left column (by default reads Analog 1, Analog 2, etc.) is specified in the Description field in the **Analog Inputs** tab in the setup pages. The Scaled Analog Value of the input is shown to the right of the analog description text.

Note: When Analog Input 1 and 3 are setup in differential mode, Analog Input 2 and 4 will display the same Scaled Analog Value as their differential pair.

Digital 1-4

The analog inputs may be configured to act as digital inputs, as shows in figure 3.1b. Refer to **2.4.9 Analog Inputs** to configure this mode.

Frequency

This row displays the current frequency of the input. This row can be displayed (as shown) or not displayed by checking or clearing the appropriate box on the **Control Page Setup** tab. The text in the left column (by default reads Frequency) is specified in the Description field on the **Frequency** tab in the setup pages. The frequency of the sensor is shown to the right of the description text.

External Variables

These rows display the current state of the four external variables used in the BASIC script. These rows can be displayed (as shown in figure 3.1a) or not displayed (figure 3.1b) by checking or clearing the appropriate boxes in the extvar setup page. The External Variables setup page is found in the **Script** tab (“Configure” link).

The text in the left column is specified in the Description field on the extvar setup page. The state of the extvar is shown to the right of the description text. By default the status text will read **ON** or **OFF**. To the right of the extvar status, buttons and an input box is provided to control the state/value of the external variable.

More information on external variables can be found in **Appendix G: BASIC Scripts**.

Current Time

Displays the current time that is set using the **Date/Time** tab in the setup pages.

3.2 XML Operation

Custom XML computer applications may be created to monitor and control X-320™. This method does not use a web browser. There are three XML pages that can be used to monitor or control X-320™, state.xml, eventX.xml, and Diagnostics.xml.

Refer to **Appendix E: External Server and Remote Services** for more information on network configurations when using XML.

3.2.1 state.XML

XML Monitor All Functions

The state of the I/Os, Counters, Rate, Frequency Input, Analog Input, and Sensors can be monitored by sending a request to port 80 (or port specified in setup). This can be demonstrated by entering the following URL into the address bar of a web browser (substituting the IP address as necessary):

```
http://192.168.1.2/state.xml
```

The following state.xml page is returned:

```
<datavalues>
  <io1state>0</io1state>
  <io2state>0</io2state>
  <hightime1>0.000</hightime1>
  <hightime2>0.000</hightime2>
  <rawCount1>10</rawCount1>
  <count1>10.00</count1>
  <rawCount2>38</rawCount2>
  <count2>38.00</count2>
  <rawRate1>0.000</rawRate1>
  <rate1>0.00</rate1>
  <rawRate2>0.000</rawRate2>
  <rate2>0.00</rate2>
  <rawFrequency>0.000</rawFrequency>
  <frequency>0.00</frequency>
  <freqAlrm>2</freqAlrm>
  <an1state>1</an1state>
  <an2state>49.9150</an2state>
  <an3state>0.06</an3state>
  <an4state>0</an4state>
  <an1Alrm>0</an1Alrm>
  <an2Alrm>1</an2Alrm>
  <an3Alrm>2</an3Alrm>
  <an4Alrm>0</an4Alrm>
  <units>F</units>
  <sensor1temp>78.0</sensor1temp>
  <sensor2temp>x.x</sensor2temp>
  <sensor3temp>x.x</sensor3temp>
  <sensor4temp>x.x</sensor4temp>
  <sensor5temp>x.x</sensor5temp>
  <sensor6temp>x.x</sensor6temp>
  <s1Alrm>1</s1Alrm>
  <s2Alrm>0</s2Alrm>
  <s3Alrm>0</s3Alrm>
  <s4Alrm>0</s4Alrm>
  <s5Alrm>0</s5Alrm>
  <s6Alrm>0</s6Alrm>
  <extvar0>2.00</extvar0>
```



```

<extvar1>1.00</extvar1>
<extvar2>0.00</extvar2>
<extvar3>0.00</extvar3>
<serialNumber>00:0C:C8:00:00:00</serialNumber>
<time>1304511052</time>
</datavalues>
    
```

The numbers enclosed by the tags, <tag>, indicate the current state or value monitored by X-320™. Values for each tag are described in the table below.

XML computer applications will open a TCP/IP socket with the X-320™ and send a GET command followed by the state.xml command string. (See **Appendix E** for instructions on using GET.)

XML Tags*	Monitor Values
<ioXstate>	0 = I/O OFF 1 = I/O ON
<hightimeX>	The duration in seconds that the input was last held in the ON state.
<rawCountx>	The number of times the input has transitioned from OFF to ON.
<countX>	The scaled count value (rawCount * multiplier + offset).
<rawFrequency>	Signal frequency at the input, Hz.
<frequency>	Scaled frequency reading from the Frequency Input.
<freqAlrm>	Current Condition of the alarms. 0 = Normal 1 = Alarm 1 2 = Alarm 2
<anXstate>	Scaled analog value from the corresponding Analog Input
<anXAlrm>	Current state of the alarms 0 = Normal 1 = Alarm 1 condition 2 = Alarm 2 condition
<units>	F = <i>Fahrenheit</i> C = <i>Celsius</i>
<sensorXtemp>	x.x = Indicates that no digital temperature sensor is attached. 77.3 = Current temperature. H24.9 = Current humidity reading.
<sXAlarm>	Current state of the sensor alarms 0 = Normal 1 = Alarm 1 2 = Alarm 2
<extvarX>	Value of each External Variable.
<serialNumber>	00:00:00:00:00:00, serial number of X-320™.
<time>	Time displayed in "epoch time" (number of seconds since January 1, 1970)

* 'X' is replaced by the I/O number, or Sensor number.

XML Control

Commands can be sent to the X-320™ to control the outputs, counters, and external variables.

Relay State Control

Commands are sent using a variable called relayXState (X is replaced by 1 for output 1, or 2 for output 2). A few examples of using relayXState are given here.

Command	Description
state.xml?relay1State=0	Turn Output 1 <i>OFF</i>
state.xml?relay1State=1	Turn Output 1 <i>ON</i>
state.xml?relay2State=0	Turn Output 2 <i>OFF</i>
state.xml?relay2State=1	Turn Output 2 <i>ON</i>

Pulse Relay

When the pulse command is sent, the output will turn **ON** for the Pulse Duration specified in the **Digital I/O** setup page. It is also possible to send a pulse time command that is different than the configured Pulse Duration. This is done by sending a pulseTime variable.

The pulseTime variable does not change the Pulse Duration in the setup page and it is not stored or recorded. The pulseTime variable only changes the duration for the single pulse initiated by that command. In other words, you must issue the pulseTime command for each pulse command that differs from the preset value.

For example, if the X-320™ is configured for a Pulse Duration of 1.5 seconds. To issue one 1.5 second pulse, three 5 second pulses, and another 1.5 second pulse to Output 1, you would issue the following commands.

Command	Description
state.xml?relay1State=2	Pulse Output 1 for the preset time (1.5 seconds).
state.xml?relay1State=2&pulseTime1=5	Pulse Output 1 for 5 seconds.
state.xml?relay1State=2&pulseTime1=5	Pulse Output 1 for 5 seconds.
state.xml?relay1State=2&pulseTime1=5	Pulse Output 1 for 5 seconds.
state.xml?relay1State=2	Pulse Output 1 for the preset time (1.5 seconds).

XML Set Counter

The counter value can be set using the countx command. Refer to **2.4.7 Digital I/O Tab** for information on maximum count values.

Command	Description
state.xml?count1=200	Set counter1 to 200.

Message Acknowledgment

By default, when commands are sent to X-320™, the state.xml page is returned. The xml reply can be disabled by adding the noReply field as follows:

Command	Description
state.xml?relay1State=1&noReply=1	Turn Output 1 <i>ON</i> without returning state
state.xml?relay1State=0&noReply=1	Turn Output 1 <i>OFF</i> without returning state

3.2.2 eventX.XML

The outputs can be configured to turn **ON**, turn **OFF**, or pulse at specified times. Instructions to change the output state at a given time (or periodically) are called events. X-320™ supports 100 events, which can be monitored through the eventX.xml page (where X is the event number 0-99). This can be demonstrated by entering the following URL into the address bar of a web browser:

```
http://192.168.1.2/event0.xml
```

The following event.xml page is returned:

```
<event0>
  <active>yes</active>
  <currentTime>11/14/2010 15:14:09</currentTime>
  <nextEvent>11/15/2010 15:15:00</nextEvent>
  <period>1 d</period>
  <count>0</count>
  <relay>1</relay>
  <action>turn relay(s) on</action>
  <pulseDuration>0.5 s</pulseDuration>
</event0>
```

The tags used by X-320™ are described below:

Tags*	Description
<eventX>	Event tag where X represents the event number (0-99).
<active>	This field indicates whether or not the event is active. The text <code>yes</code> indicates that the event is active and the event will occur at the next event time. The text <code>no</code> indicates that the event is inactive and the event will no longer take place.
<currentTime>	This field indicates the current date and time as MM/DD/YYYY HH:MM:SS in 24-hour format.
<nextEvent>	The next time the event is scheduled to occur is given as MM/DD/YYYY HH:MM:SS. If an event is inactive, this field will display the date and time as xx/xx/xxxx xx:xx:xx.
<period>	For events that occur more than one time, this field indicates the period of the event (time between event occurrences). The unit of time is indicated after the value (seconds (s), minutes (m), hours (h), days (d), or weeks (w)). If this field is set to 0, then the event has been disabled. For example <code>1d</code> would be a period of 3 days.
<count>	This field indicates the number of remaining times the event will occur. If this field is 0 and the event is active, then the event is always on.
<relay>	Event will apply to the output specified (1 or 2)
<action>	One of the follow actions is applied to the event. <pre>turn relay(s) on turn relay(s) off pulse relay(s) toggle relay(s) set extVar0 clear extVar0 change schedules</pre>
<pulseDuration>	This field indicates the time (in seconds) that the output will be turned on.

* 'X' is replaced by the I/O number.

3.2.3 Diagnostics.XML

There is a special diagnostics.xml that can be requested by entering the following in the web browser address bar:

```
http://192.168.1.2/diagnostics.xml
```

The following diagnostics.xml file is returned.

```
<datavalues>
  <internalTemp>89.3</internalTemp>
  <vin>12.0</vin>
  <internal6Volt>6.2</internal6Volt>
  <memoryPowerUpFlag>1</memoryPowerUpFlag>
  <devicePowerUpFlag>1</devicePowerUpFlag>
  <powerLossCounter>1</powerLossCounter>
</datavalues>
```

Diagnostic tags are given in the table below.

Tag	Description
<internalTemp>	Indicates the internal temperature of the device.
<vin>	Indicates the DC voltage that is applied to the VIN+ and Vin- terminals.
<internal6Volt>	Indicates the DC voltage of the internal 6V power supply.
<memoryPowerUpFlag>	Indicates a loss of power to the capacitor-backed real-time clock. A value of 1 indicates that the real-time clock lost power. This should only happen if the device has lost power for several days. There is an internal capacitor that can power the real-time clock for an extended period of time, even if the main power is lost. If the real-time-clock loses power, the time will have to be reset. By default, this will read 1 until it is set to 0.
<devicePowerUpFlag>	Indicates a loss of power to the device. This field can also be set to 0. A value of 1 means the X-320™ has lost power at least one time since the flag was set to 0.
<powerLossCounter>	This field is a count of how many times the X-320™ has lost main power.

The above flags may be cleared by requesting the diagnostics.xml file along with request parameters.

To clear the real-time clock power loss flag:

```
http://192.168.1.2/diagnostics.xml?memoryPowerUpFlag=0
```

To clear the device power loss flag:

```
http://192.168.1.2/diagnostics.xml?devicePowerUpFlag=0
```

To clear the powerLossCounter flag:

```
http://192.168.1.2/diagnostics.xml?powerLossCounter=0
```

Resetting of multiple flags may be done at one time by placing & between each request:

```
http://192.168.1.2/diagnostics.xml?memoryPowerUpFlag=0&devicePowerUpFlag=0
```

Note: Requests for the diagnostics.xml file do not require a password.

3.3 GET Requests

3.3.1 Using GET for Control and Monitoring

No Password

GET requests to the device for XML files.

Example request about.html:

```
GET /about.html HTTP/1.1\r\n\r\n
```

Example turn Output 1 On:

```
GET /state.xml?relay1State=1\r\n\r\n
```

Password Enabled

If the Control Password is enabled on X-320™ and the state.xml page is requested through a browser, the user will be prompted for a password. If the XML request is sent from an XML application, the html request will need to contain the password, encoded as Base64.

The following is an html request header without the password:

```
GET /state.xml?relay1State=1&noReply=1 HTTP/1.1 (Terminated with two \r\n.)
```

The following example adds the password:

```
GET /state.xml?relay1State=1&noReply=1 HTTP/1.1 (Terminated with \r\n.)
Authorization: Basic bm9uZTp3ZWJyZWxheQ== (Terminated with two \r\n.)
```

bm9uZTp3ZWJyZWxheQ== is the Base64 encoded version of the user "name:password,"
none:webrelay.

A utility is provided at <http://www.controlbyweb.com/encoder> to encode the password. Simply type the string username:password into the website and press 'Encode'.

3.3.2 http (GET) Event Configuration

Events can be configured using a GET request through http. For example, to configure event 5 to start on November 19, 2010 at 12:00:00 and continue every day, turning Output 1 on, send the following request (using the default IP address):

```
http://192.168.1.2/eventSetup.srv?
e5=1290168000;1;3;0;0;1;4;0;Event5Desc;127;1;
```

The basic format of the request is:

*e(event#)=epoch time;period;period units;count;schedule#;action;pulse
duration;0;description;days;action#;*

Parameter	Description
e5=	Parameter Name: Each event has an identifier (0-99). In this case the parameter name is e5. Event 100 would be e99.
1290168000	Epoch Time: The number of seconds up to the desired start date since January 1, 1970.
1	Period: The period value.
3	Period Units: The units of the period, 0-Seconds, 1-Minutes, 2-Hours, 3-Days, 4-Weeks.
0	Count: Number of times the event will occur. (0 = continuous)
0	Schedule #: The schedule where the event will occur (0-4). 0 = schedule 0, 1= schedule 1, and so forth.
1	Action: 0-No Action, 1-Turn output on, 2-Turn output off, 3-Pulse output, 4-Toggle output, 5-change schedules, 7-Set extVar0, 8-Clear extVar0.
4	Pulse Duration: Pulse duration when using the pulse output action.
0	Next Occurrence: This is a report value only, indicating the next time this event will occur in Epoch Time. When setting an event leave this at 0.
Event5Desc;	Description: Text description of the event, up to 20 characters can be entered.
127	Days: This number represents which days the event will occur. This value is the base ten version of a binary number where each bit represents one day of the week. Bit 0 is Saturday and Bit 6 is Sunday. See the table below for some common values.
1	Action #: This number represents which output will be affected by the event. This value is the base ten version of a binary number where each bit represents the ON/OFF state of one output. Bit 0 corresponds to output/schedule 1, and Bit 3 corresponds with schedule 4.

3.3.3 Common Base Ten Values for Event Days

Sunday	Monday	Tuesday	Wednesday	Thursday	Friday	Saturday	Base 10 Value
Bit 6	Bit 5	Bit 4	Bit 3	Bit 2	Bit 1	Bit 0	--
1	1	1	1	1	1	1	127
0	1	1	1	1	1	0	62
0	1	0	1	0	1	0	42
0	0	1	0	1	0	0	20
0	0	0	0	0	0	1	1

3.4 Modbus Operation

X-320™ can be controlled and monitored using Modbus/TCP protocol. This provides a standard means of using X-320™ with devices and software from other manufacturers. This section is not a tutorial on Modbus and it is assumed that the reader is already familiar with Modbus. Detailed Modbus information can be found at <http://www.modbus.org>.

Note: Modbus communications are disabled whenever the Control Password is enabled. This is because Modbus/TCP does not provide a mechanism for password protection. Make sure the Control Password is disabled (default) and Modbus functionality is enabled on the Advanced Network.

X-320™ functions as a Modbus slave. Host devices, such as PLCs, open a connection with X-320™ on port 502 (configurable under **Advanced Network** tab) and then send requests to read or set output states, read input states, or read frequency inputs analog inputs, or sensor values. When X-320™ receives a command, it will perform the desired function and return a response.

The following sections provide an overview and explanation of Modbus operation. **Appendix H: Modbus Details** provides further packet and protocol information.

3.4.1 X-320™ Function Code Summary

X-320™ supports the following function codes:

Code Name	Modbus Function	X-320 Feature	X-320 Start Address	
			Hexadecimal	Decimal
Read Coils	01	Outputs 1-2	0x0000-0x0001	0-1
Read Discrete Inputs	02	Inputs 1-6	0x0000-0x0001	0-1
Read Analog Inputs	03	Analog Inputs 1-4	0x0010-0x0016	16-22
Read Sensors	03	Sensors 1-6	0x0110-0x011A	272-282
Read Counters	03	Counters 1-2	0x0210-0x0212	528-530
Read Frequency Input	03	Frequency Input 1	0x0214	532
Write Single Coil	05	Outputs 1-2	0x0000-0x0001	0-1
Write Multiple Coils	15	Outputs 1-2	0x0000-0x0001	0-1
Pulse Coils	16	Outputs 1-2	0x0310-0x03	0-1
Set Counter	16	Counters 1-2	0x0000-0x0001	0-1
Read Extvars	03	Extvars 0-3	0x410-0x416	1040-1046
Write Extvars	16	Extvars 0-3	0x410-0x416	1040-1046

Multiple commands may be sent without closing and re-opening the connection, but if no data is transferred for 50 seconds, the connection will time out and close. To keep the connection open, a read request can be sent periodically.

X-320™ has two TCP sockets available for Modbus/TCP. This allows two connections to be open at one time. Requests for more than two open connections will be rejected.

When errors occur, an error code is returned. Most Modbus client software will interpret this code in a human readable form. The code is comprised of the original function code plus 0x80. For example, an error during the read coils function 0x01 would return 0x81. Each error has a qualifying exception number. The following are the possible exception codes and their meanings:

0x01 - Function code not supported (also when Modbus is disabled in the setup pages).

0x02 - Incorrect starting address/quantity of output combination.

3.4.2 PLC Device Addressing

There are generally two schemes for accessing Modbus devices, The first is by specifying the Modbus function code, memory type, and address. The second, sometimes called PLC addressing, requires only the address.

Modbus protocol uses four different address ranges for discrete inputs, coils, input registers, and holding registers. The function code determines the address range of the message. The following are common function codes and their respective address ranges.

Code Name	Modbus Function	Data Type*	PLC Address Mode 485	PLC Address Mode 584/984
Coils (Read/Write)	01, 05, 15	Discrete	1-1000	1-10000
Discrete Inputs (Read only)	02	Discrete	1001-2000	10001-20000
Registers (Read only)	04	8-64 bits	3001-4000	30001-40000
Holding Registers (Read/Write)	03, 06, 16	8-64 bits	4001-5000	40001-50000

* Data types may be implemented at the discretion of the manufacturer. Address ranges may also overlap. Discrete is a binary or boolean value, 1 or 0.

Function codes, memory types, and addresses can be converted to the PLC addressing equivalent using the table below. To use the table, look up the row corresponding to the Modbus function code. Then take the desired X-320™ feature address and add to it the address offset in the PLC address mode column.

$$\text{Input Address} + \text{PLC Base Address} = \text{PLC Address}$$

For example, to read discrete Input 2

Input Address	1
PLC Base address	1001
PLC Address	1002

Programming the PLC to read from 1002 will return the value of Input 2.

Code Name	Modbus Function	X-320 Addresses	Data Type	PLC Address Mode 485	PLC Address Mode 584/984
Read Coils	01	0-1 (Outputs 1-2)	Discrete	Addr + 1	Addr + 1
Read Discrete Inputs	02	0-1 (Inputs 1-2)	Discrete	Addr + 1001	Addr + 10001
Read Holding Registers	03	16-22 (Analog 1-4)	32-bit float	Addr + 4001	Addr + 40001
		272-282 (Sensors 1-6)	32-bit float	Addr + 4001	Addr + 40001
		528-530 (Counters 1-2)	32-bit float	Addr + 4001	Addr + 40001
		532 (Frequency 1)	32-bit float	Addr + 4001	Addr + 40001
		1040-1046 (Extvars 0-3)	32-bit float	Addr + 4001	Addr + 40001
Write Coils	05	0-1 (Outputs 1-2)	Discrete	Addr + 1	Addr + 1
Write Multiple Coils	15	0-1 (Outputs 1-2)	Discrete	Addr + 1	Addr + 1
Write Multiple Registers	16	528-530 (Counters 1-2)	32-bit int	Addr + 1	Addr + 1
		784-786 (Outputs 1-2)	32-bit float	Addr + 1	Addr + 1

For 32-bit numbers, two registers must be read starting at the desired address, examples of each are given for the applicable functions.

3.4.3 X-320™ Full Address Table

The table below gives commonly used function codes, memory types, data sizes, and equivalent PLC addresses for accessing the X-320. The data size will be the same regardless of the addressing mode.

	Function Code	Address (Decimal)	Data Size	PLC Address Mode 485	PLC Address Mode 584/984
Read Output 1*	01	0	Discrete	1	1
Read Output 2*	01	1	Discrete	2	2
Write Output 1*	05	0	Discrete	1	1
Write Output 2*	05	1	Discrete	2	2
Read Input 1 State*	02	0	Discrete	1001	10001
Read Input 2 State*	02	1	Discrete	1002	10002
Read Input 3 State*	02	3	Discrete	1004	10004
Read Input 4 State*	02	4	Discrete	1005	10005
Read Input 5 State*	02	5	Discrete	1006	10006
Read Input 6 State*	02	6	Discrete	1007	10007
Read Analog Input 1*	03	16	32-bit Float	4017	40017
Read Analog Input 2*	03	18	32-bit Float	4019	40019
Read Analog Input 3*	03	20	32-bit Float	4021	40021
Read Analog Input 4*	03	22	32-bit Float	4023	40023
Read Sensor 1	03	272	32-bit Float	4273	40273
Read Sensor 2	03	274	32-bit Float	4275	40275
Read Sensor 3	03	276	32-bit Float	4277	40277
Read Sensor 4	03	278	32-bit Float	4279	40279
Read Sensor 5	03	280	32-bit Float	4281	40281
Read Sensor 6	03	282	32-bit Float	4283	40283
Read Counter 1*	03	528	32-bit Float	4529	40529
Read Counter 2*	03	530	32-bit Float	4531	40531
Read Frequency Input	03	532	32-bit Float	4533	40533
Read Extvar 0	03	1040	32-bit Float	5041	41041
Read Extvar 1	03	1042	32-bit Float	5043	41043
Read Extvar 2	03	1044	32-bit Float	5045	41045
Read Extvar 3	03	1046	32-bit Float	5047	41047
Write Extvar 0	16	1040	32-bit Float	5041	41041
Write Extvar 1	16	1042	32-bit Float	5043	41043
Write Extvar 2	16	1044	32-bit Float	5045	41045
Write Extvar 3	16	1046	32-bit Float	5047	41047
Write Multiple Outputs*	15	0	8-bit	1	1
Set Counters*	16	528	32-bit int	1	1
Pulse Outputs*	16	784	32-bit Float	1	1

*Feature is multiplexed (shared) and must be configured for the specific function, such as an input or output, analog or digital.

3.4.4 Read Coils - Modbus Function Code 01 (0x01)

Read the state of the digital outputs, when these are configured as outputs.

Request

Start Address: 0x0000 (coil 1) to 0x0001 (coil 2)

Coil Quantity: 0x0001 (1 coil) to 0x0002 (2 coils)

Both Outputs may be read at the same time by specifying the correct starting address and quantity of coils to be read.

Response

The X-320™ will respond to the request with a data field of one byte, each bit representing the coil status. A '1' indicates the Output is **ON**. A '0' indicates that the Output is **OFF**.

Bit zero of the return value will be the state of the coil corresponding to the start address. For example, if a start address of 0x0001 is used, bit zero will be the status of Output 2.

If neither of the I/Os are configured as outputs, the request will return 0x00 for the status byte.

Coil State Byte							
Bit 7	6	5	4	3	2	1	Bit 0
X	X	X	X	X	X	Output 2	Output 1

Possible coil values when a start address of 0x0000 is used:

Data Byte			Output 2 State	Output 1 State
Hexadecimal	Decimal	Binary		
0x00	0	0000	OFF	OFF
0x01	1	0001	OFF	ON
0x02	2	0010	ON	OFF
0x03	3	0011	ON	ON

Errors

The sum of the start address and coil count cannot exceed the maximum coil count or an error response will be returned.

The following are possible error responses.

Coil Read Error Function Code (1 byte): 0x81

Exception Codes (1 byte): 0x01 – Function code not supported.

0x02 – Incorrect combination of start address and quantity of Outputs

3.4.5 Read Discrete Inputs – Modbus Function Code 02 (0x02)

X-320™ has two types of discrete inputs, Digital I/O and Analog Inputs. This function returns the state of the discrete inputs when they are configured as digital inputs.

The Digital I/O must be configured as inputs under the **Digital I/O** tab. The switching thresholds are fixed.

Analog inputs must be configured as digital inputs in the **Analog** tab. The voltage level at which the inputs switch between high and low can be configured. Please refer to **2.4.9 Analog Tab** for more information.

Request

Start Address: 0x0000 (input1) to 0x0005 (Analog Input 4)

Input Quantity: 0x0001 to 0x0006

The sum of the starting address and the quantity of coils must not be greater than 0x0006. For example, if you want to read 0x0002, both inputs, then the start address must be 0x0000. To read the second input only the start address is 0x0001 with a quantity of 0x0001.

Response

The inputs states are indicated by bits one and two of the status byte. A 1 indicates that the input is switched high **ON**. A 0 indicates that the input switched low **OFF**. Pull-up and pull-down resistor settings are valid logic input levels. **ON** will show when the internal pull-up is enabled and the input is open. **OFF** will be read when the internal pull-down is enabled and the input is open.

Bit zero of the return value will be the state of the coil corresponding to the start address. For example, if a start address of 0x0001 is used, bit zero will be the status of input 2.

Note: If neither I/O is configured as an input, the response will show the value of the internal pull resistors.

When reading all 6 inputs, the following table shows the bit positions.

Discrete Input State Byte							
Bit 7	6	5	4	3	2	1	Bit 0
X	X	Analog Input 4	Analog Input 3	Analog Input 2	Analog Input 1	Input 2	Input 1

Errors

Input Read Error Function Code (1 Byte): 0x82

Exception codes (1 Byte):

- 0x01 – Function not supported.
- 0x02 – Incorrect combination of start address and input quantity.

3.4.6 Read Sensors – Modbus Function Code 03 (0x03)

The Read Holding Registers function is used for the counters, frequency input, analog inputs, temperature and humidity sensors.

Request

32-bit sensor values are read from 16-bit register pairs. Consequently, sensor addresses and registers must be even numbers.

Analog Input Start Addresses

Start Address: 0x0010 (Analog Input1) to 0x0016 (Analog Input 4)

Input Quantity: 0x0002 to 0x0008

Temperature and Humidity Sensor Start Addresses

Start Address: 0x0110 (Sensor Input1) to 0x011A (Sensor Input 6)

Input Quantity: 0x0002 to 0x000C

Counter Input Start Addresses

Start Address: 0x0210 (Counter 1) to 0x0212 (Counter 2)

Input Quantity: 0x0002 to 0x0004

Frequency Input Start Address

Start Address: 0x0214

Input Quantity: 0x0002

Pulse Rate Input Start Addresses

Start Address: 0x0216 (Rate Counter 1) to 0x0218 (Rate Counter 2)

Input Quantity: 0x0002 to 0x0004

Extvars Start Addresses

Start Address: 0x0410 (Extvar 0) to 0x0416 (Extvar 3)

Input Quantity: 0x0002 to 0x0008

Response

32-bit floating-point values are returned, either as little-endian or big-endian numbers, depending on the configuration in the **Advanced Network** tab.

With little-endian ordering, a temperature reading of sensor 1 (0x0110) would return 0x800042A2. The least significant word would be 8000 hex and the most significant word would be 42A2. This hexadecimal value converts to a temperature reading of 81.25 degrees.

If a temperature or humidity sensor is not installed, a value of 0xFFFFFFFF (NaN) is returned. Other inputs will show measured values of the open circuits.

Errors

Sensor Read Error Function Code (1 byte): 0x83

Exception Codes (1 byte): 0x01 – Function not supported.
 0x02 – Incorrect combination of start address and input quantity

3.4.7 Write Single Coil – Modbus Function Code 05 (0x05)

Outputs may be controlled one at a time, if the Digital I/O is configured as an output.

Request

Start Address (2 bytes): 0x0000 (Output 1) – 0x00001 (Output 2)
Output Value (1 byte): 0x00 (OFF), 0xFF(ON)
Padding (1 byte): 0x00

Response

The response mirrors the requested state, 0x00 or 0xFF.

Errors

Single Coil Write Error Function Code (1 Byte): 0x85

Exception codes (1 Byte): 0x01 – Function not supported.
 0x02 – Address out of range.
 0x03 – Padding value.

No error will be returned if an I/O pin is configured as an input instead of an output.

3.4.8 Write Multiple Coils - Modbus Function Code 15 (0x0F)

One byte can be written to set the state of both Outputs, each bit representing one Output.

Request

Output states are controlled by specifying the start address of the first Output to be controlled, the count of the Outputs to be affected, and the Output state byte.

An output value of 0xFFFF would be used to turn **ON** both of the Outputs in the range or 0x0000 to turn them **OFF**. In the above example, the output value 0xFF would turn Outputs 1-2 **ON**.

Start Address (2 bytes): 0x0000 (Output 1) – 0x0001 (Output 2)

Output Quantity (2 bytes): 0x0001 – 0x0002

Byte Count (1-2 bytes): 0x01

Output Value (1 bytes): 0x0000 – 0x0003

Output State Byte							
Bit 7	6	5	4	3	2	1	Bit 0
X	X	X	X	X	X	Output 2	Output 1

Response

The quantity value is returned.

Errors

Multiple Coil Write Error Function Code (1 Byte): 0x8F

Exception codes (1 Byte): 0x01 – Function not supported.

0x02 – Incorrect combination of start address and Output quantity

0x03 – Byte count out of range.

No error message is returned when the Digital I/O pins are configured as inputs.

3.4.9 Write Multiple Registers – Modbus Function Code 16 (0x10)

The Modbus Write Multiple Registers function can be used to set the counter to a specific value or pulse the Outputs.

Request

Set Counters

The counter value is specified using a 32-bit integer (not a floating point number).

Start Address (2 bytes):	0x0210 (counter 1) - 0x0212 (counter 2)
Register Quantity (2 bytes):	0x0002 - 0x0004 (2 registers for each counter, even number)
Byte Count (1 byte):	0x04 - 0x08 (Multiples of 4)
Counter Quantity (4 bytes/Counter):	0x00000000 – 0xFFFFFFFF

Set Output Pulse

The Modbus Write Multiple Registers function is used to pulse the output(s) for a specified time. When X-320™ receives this command, it immediately turns the appropriate output(s) **ON** (if not already on) and starts the pulse timer. The output(s) are selected by writing the pulse time in seconds to the register(s) associated with the desired output(s).

The pulse time is specified using floating point format in the register value field and can range from 0.1 seconds to 86400 seconds (1 day). When the pulse time expires, the Output will be turned **OFF**. If a pulse time command is sent with a value greater than 86400, the pulse timer will be set to 86400. If a pulse time command is sent with a value less than 0.1, the pulse timer will be set to 0.1.

If any commands are sent to X-320™ (Modbus, XML, SNMP, or HTML) before the pulse timer has expired, the pulse timer will be canceled immediately and the new command will be executed.

IEEE 754 floating point format is used for the pulse time. X-320™ may be configured for little-endian or big-endian transmission. The endian-ness is configured in the **Advanced Network** tab. (See **2.4.3 Advanced Network Tab** for more information.)

Start Address (2 bytes):	0x0310 (output 1) – 0x0312 (output 2)
Register Quantity (2 bytes):	0x0002 – 0x0004 (2 registers for each Output, even number)
Byte Count (1 byte):	0x04 – 0x08 (Multiples of 4)
Pulse Duration (4 bytes/Output):	0x3DCCCCC – 0x47A8C000 (big-endian) 0xCCCC3DCC – 0xC00047A8 (little-endian)

Response

The request is acknowledged by responding with the register quantity that was requested.

Errors

Pulse Function code Error (1 Byte):	0x90
Exception codes (1 Byte):	0x01 – Feature not supported. 0x02 – Address quantity not an even number. Incorrect combination of start address and Output count.

3.5 Email Notification

3.5.1 Email Notification Description

X-320™ can be configured to send messages to five email addresses when certain events occur. Events that can trigger email messages include I/O state changes, Frequency Input changes, Analog Input changes, temperature/humidity changes, and commands sent from a BASIC script.

When an email message is sent, it looks similar to this:

```
X-320

Trigger: Analog 1

Output 1: ON
Count 1: 5.00
Rate 1: 0.00 Hz
Output 2: OFF
Count 2: 0.00
Rate 2: 0.00 Hz
Frequency: 0.00 Hz
Frequency(Total): 23.00 Hz
Analog 1: 4.1 V
Analog 2: 4.0 V
Analog 3: 4.1 V
Analog 4: 4.1 V
Sensor 1: 76.2° F
Sensor 2: 73.7° F
Sensor 3: 32.0° F
Sensor 4: 84.5° F
Sensor 5: 22.6° F
Sensor 6: xx.x
```

Note: I/O, Count, Rate, Frequency Inputs, Analog Inputs, and Sensor names as well as ON and OFF status text may be customized by the user (installer) in the setup pages. The same field names are used on the Control Page.

Subject Line

The top line (that reads X-320), appears in the subject line of the email message. This is the same text that appears as the header on the **Control Page**. It is set in the Main Header Text field under the **Control Page Setup** tab.

Trigger

The first line displayed in the body of the message shows the event that triggered the message. The text "Trigger" will always appear and cannot be changed. The remaining text includes the trigger name, and what caused the trigger. The text that describes the trigger and its current state are configured in the setup pages as described below.

Current Status of the Digital I/O, Frequency Input, Analog Input, and Sensors

The remainder of the email message will display the same information shown on the **Control Page**. Fields not displayed in the **Control Page** will not be included in the email message. Displayed fields may be configured in the **Control Page Setup** page.

3.5.2 Email Notification Setup

Email notification requires that the following fields are properly configured. See **Section 2.4.2** for a description of each field.

Network Tab

- IP Address
- Subnet Mask
- Gateway
- Preferred DNS Server (this is required if Mail Server is entered by name and not by IP address)
- Alt DNS Server
- Mail Server (SMTP)
- User Name (If Required)
- Password (If Required)
- Return Email
- Email 1
- Email 2
- Email 3
- Email 4
- Email 5

*Note: X-320™ must be power-cycled (power disconnected, then reconnected) before network settings take effect. Only the settings on the **Network** tab require power-cycling before taking effect.*

Email triggers can be generated within a BASIC script (See **Appendix G: BASIC Scripts**), or can be explicitly defined for each Digital I/O, frequency input, analog input, and sensor under the **I/O**, **Frequency**, **Analog**, and **Sensors** tabs.

The email options and recipients for each Digital I/O, Frequency Input, Analog Input, and Sensor are configured separately. Select the the Email Option and the checkbox for the desired email recipient for each I/O, Frequency Input, Analog Input, and Sensor.

Once the email settings are entered, the email functionality can be tested by entering the following command:

```
http://IP address/state.xml?testEmail=1
```

For example, using the default IP address, enter:

```
http://192.168.1.2/state.xml?testEmail=1
```

This will cause an email message to be sent immediately. If the messages don't get through, the system log file may have some clues to assist in diagnosing the problem (<http://192.168.1.2/syslog.txt>). See **Appendix D: Log Files** for additional Logging Information.

Appendix A: Restoring Factory Default Settings

In the event that the IP address or passwords are forgotten, X-320™ may be restored to its original factory default settings.

1. Remove the DC power from the unit. This will also turn off and Output(s).
2. Use a thin, non-conductive object (such as a toothpick) to press and hold the small button located on the bottom of the unit. When the object is inserted, a tactile feedback can be felt as the button is depressed.

CAUTION: DO NOT USE METAL OBJECTS FOR THIS FUNCTION.

3. While depressing the button, apply power and wait for about 10 seconds before releasing the button. All settings will be back to the original factory defaults. log.txt and syslog.txt are retained.
4. Refer to **Section 2.3 Establishing Communications for Setup** to begin reconfiguration of the device.

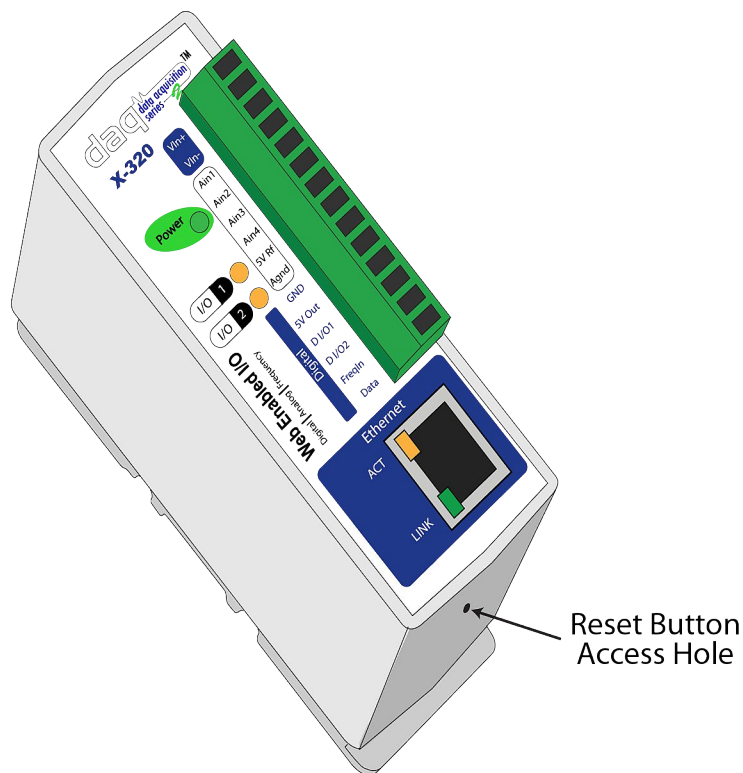

Figure Appendix A.1 - Restore Factory Defaults

Appendix B: Installing New Firmware

From time to time, updates are made to the X-320™ firmware. The firmware can be updated in the field. The procedure for updating the firmware is outlined below. Please note that it is important that this procedure is followed precisely.

Requirements

The firmware update software requires Windows XP/Vista/7 with the .Net framework installed. The .Net framework is generally installed automatically through Windows update. To install it manually, go to the following address:

<http://www.microsoft.com/downloads/details.aspx?FamilyId=333325FD-AE52-4E35-B531-508D977D32A6&displaylang=en>

Select the Download button. Once you've downloaded the installation file, double click on the installation file to install the framework.

Setup

1. Download the firmware zip file from the ControlByWeb website. Only a X-320™ image can be installed on X-320™ so make sure the correct image is being downloaded.
2. bootloader.exe will connect to the the X-320™ using default IP address 192.168.1.2, not the address currently assigned to the X-320™. After the update, all settings will be lost and the device will return to its default IP address of 192.168.1.2.

Configure the PC to the same subnet as the IP address 192.168.1.2, such as 192.168.1.10. For instructions on doing this see section **2.3 Establishing Communications for Setup**.

Note: The IP address of X-320™ will automatically be set to the default 192.168.1.2 during the update process.

Note: A crossover cable cannot be used during the update procedure, an ethernet switch will be necessary to properly update the firmware.

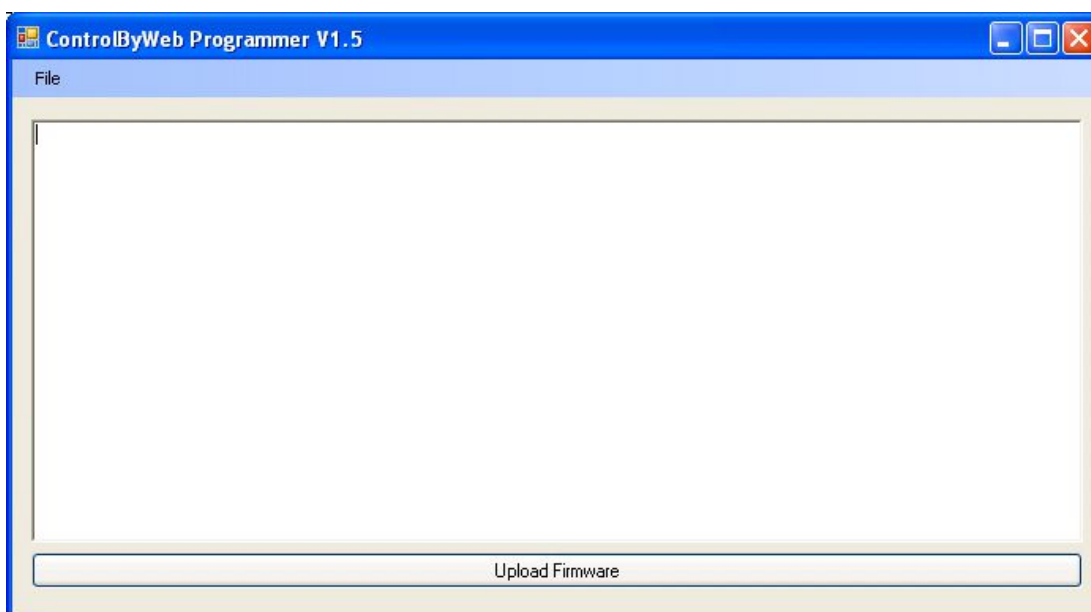

Figure Appendix B.1 - Firmware Update Utility

3. Open the bootloader.exe utility on the computer by double clicking on the downloaded file (Figure Appendix B.1).
4. Within the ControlByWeb™ Programmer utility programmer, select File, then Open. Specify the firmware image downloaded from the ControlByWeb™ web site.

Device Upgrade Procedure

Carefully follow the following steps to put the X-320™ into bootloader mode and perform the upgrade:

1. Remove DC power from X-320™.
2. Using a small, non-conductive tool, press and hold the reset button.
3. While holding the reset button, apply power to X-320™. The LINK and ACT lights will flash. Continue to hold the reset button for the next step.
4. While holding the reset button, press the Upload Firmware button at the bottom of the ControlByWeb™ Programmer window. After the programming process begins, the reset button can be released
5. Programming will take approximately 20-30 seconds, the LINK LED will stop flashing and remain lit. X-320™ will be set to factory defaults with an IP address of 192.168.1.2.
6. Refer to section **2.3 Establishing Communication for Setup** to reconfigure the X-320™. Verify the new version of firmware has been installed by viewing the default setup page with a web browser (<http://192.168.1.2/setup.html>).

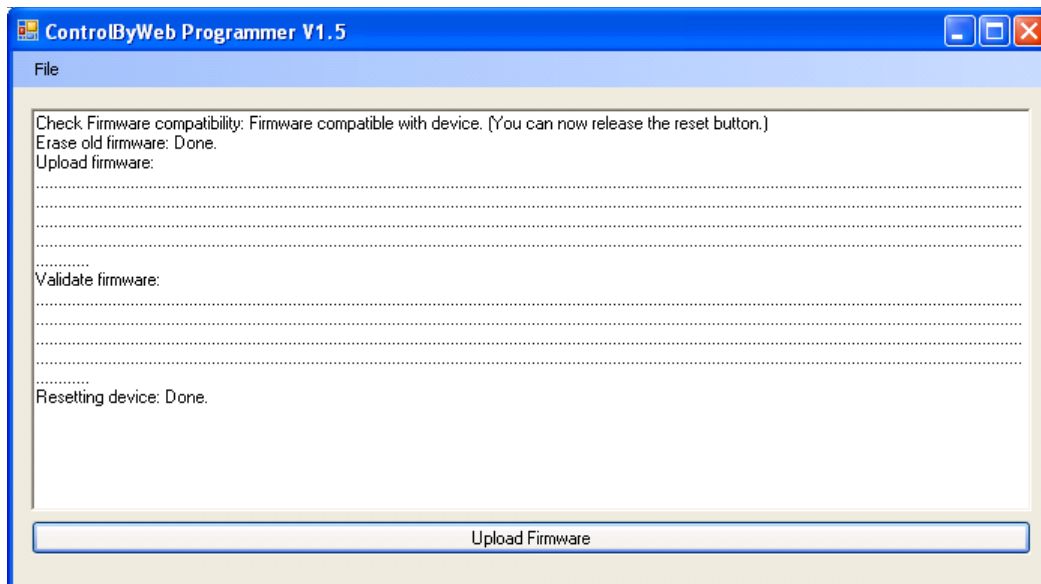

Figure Appendix B.2 - Firmware Update Complete

Appendix C: Accessing X-320™ Over the Internet

X-320™ can be monitored and/or controlled from a remote location over the Internet. Once X-320™ can be accessed on the local network, almost all of the settings required to provide remote access are in the router and not in X-320™. This guide is not meant to be a tutorial in router setup, but rather to provide a basic overview of remote access. For specific details, the user should refer to the instruction manual for the router on the local network. Users not familiar with basic IP networking should study one or more basic IP networking tutorials before proceeding (many tutorials are available on the Internet).

IP Addresses

Every device on the Internet is identified by a unique address called an IP (Internet Protocol) address. IP addresses are somewhat similar to mailing addresses in that they identify the precise logical location of the device on the Internet. The IP address identifies the global region down to the network and then the specific device on that network. IP addresses are globally maintained and assigned by an entity called the Internet Assigned Numbers Authority (IANA). IP addresses consist of four sets of numbers that range from 0 to 255 and are separated by a decimal. For example, 192.168.200.167 is an IP address.

Every device that is “directly” connected to the Internet uses a “public” IP address. X-320™ can be assigned a public IP address for direct connection to the Internet. Typically, a public IP address would only be assigned to X-320™ when it is the only device on the local network. The IP address would be obtained from an Internet Service Provider (ISP).

Due to the limited number of public IP addresses, private networks can be set up with “private” IP addresses. These addresses are used within a local network and have no global designation, they are not routed on the Internet. The following address blocks are designated for private networks (where x represents decimal numbers from 0 to 255): 192.168.x.x, 10.x.x.x, and 172.16.x.x.

A Simple Local Area Network

A small Local Area Network (LAN), can be made up of two or more computers or other devices connected to an Ethernet switch. Each device on the network is assigned a unique private IP address. For example, consider a simple network that consists of a computer, an X-320™, and a WebRelay™. In this example, the computer is assigned an IP address of 192.168.1.10, X-320™ has the IP address of 192.168.1.25 and a WebRelay™ has an IP address of 192.168.1.26. A person using the computer can access X-320™ by entering its IP address in the URL line in the browser, <http://192.168.1.25>. Similarly, WebRelay™ can be accessed by entering its unique private IP address in the URL line in the browser, <http://192.168.1.26>.

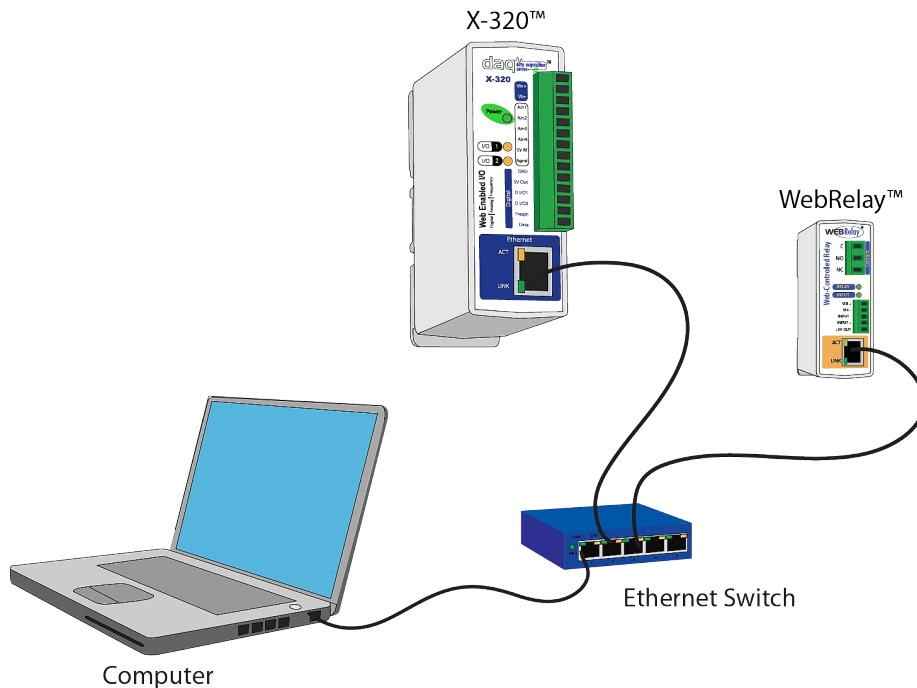

Figure Appendix C.1 - Local Area Network

A Simple LAN connected to the Internet

The LAN in the example above can be connected to the Internet by adding a router and an Internet connection. The router has two network connections. It has an Ethernet network connection to the LAN and another connection to the Internet. Often the Internet connection is called a Wide Area Network (WAN) connection. Each network connection on the router has an IP address. In our example, the IP address on the LAN side of the router has an address of 192.168.1.1. The IP address on the WAN side of the router has an IP address that has been assigned by the Internet Service Provider, such as 266.70.164.97. (This is not a valid IP address because each number cannot be larger than 255 It is used in this example for illustration purposes only.)

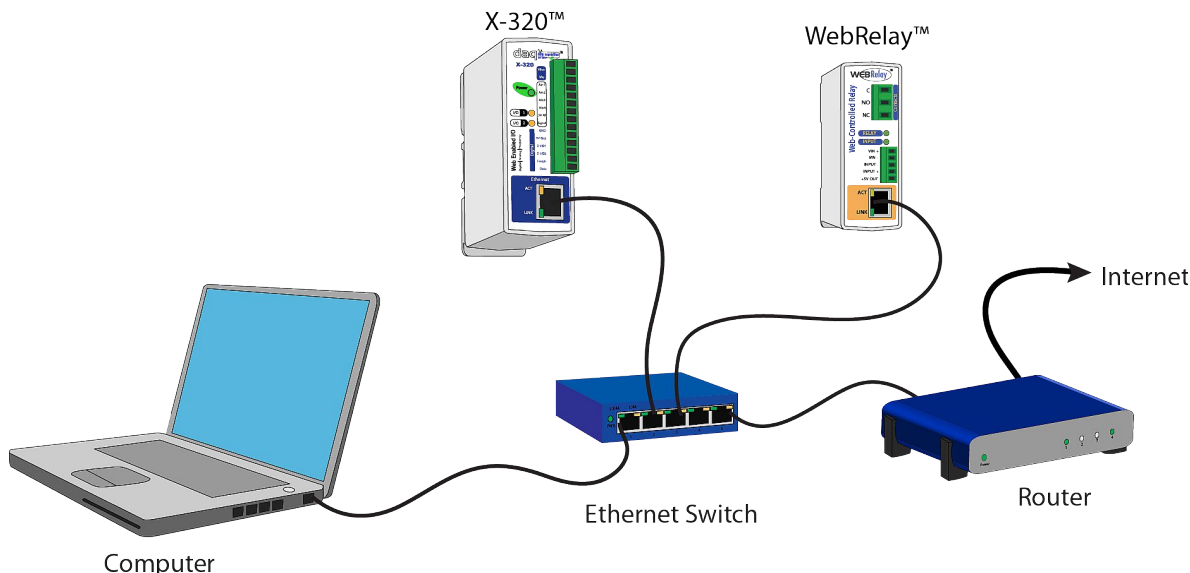

Figure Appendix C.2 - LAN Connected to the Internet

In the example, when a user on the computer needs to access a server on the Internet, the computer sends the request to the router at 192.168.1.1. The router sends the request to the ISP server on the Internet. The ISP server does not send the response directly to the computer on the LAN, but to the router at the IP address of 266.70.164.97. The router then forwards the response to the computer. This way, all devices on the LAN share a single public IP address. This is called Network Address Translation (NAT).

Port Forwarding

The router can be configured to allow outside access to X-320™ and WebRelay™. All requests from the Internet to any device on the local network must use the public IP address (266.70.164.97). With only a single IP address, TCP ports are used to identify the intended device for the incoming message.

Using the mailing address analogy, the port is similar to a post office box. The IP address specifies the location, and the port specifies the specific recipient. Port numbers can be set to any number between 1 and 65235. However, many port numbers are reserved for specific applications and should be avoided. As a general rule, numbers above 8000 are safe to use. All of the ControlByWeb™ products come from the factory with the HTTP port set to 80, which is the standard port for HTTP. In this example, X-320™ HTTP port will be changed to port 8000 and WebRelay™ port will be changed to 8001. Once the ports are changed in the two ControlByWeb™ devices, the router must be set up for port forwarding.

Port forwarding associates the IP address of each local device with an assigned port. In this example, the address 192.168.1.25 for X-320™ would be associated with port 8000. The address 192.168.1.26 for WebRelay™ would be associated with port 8001. X-320™ would be accessed from the Internet by entering the public IP address of the router, plus the port number assigned to X-320™ in the URL window of the browser, `http://266.70.164.97:8000`. All Internet requests to the router for port 8000 would be forwarded to X-320™. Similarly, all request for port 8001 would be forwarded to WebRelay™.

Note: When an HTTP request comes in to the router without the specific port specified (`http://266.70.164.97`), the router will handle this as a port 80 request (default HTTP port). In other words, `http://266.70.164.97` is exactly the same as `http://266.70.164.97:80`.

Router configuration can vary widely. Some routers have the capability of translating the addresses and the ports, which would require no port configuration change on the WebRelay. For example, the router would be configured so that messages sent to `http://266.70.164.97:8000` would be forwarded to `http://266.70.164.97:80`, which is the default HTTP port.

An example screen shot of a router configuration is given below. This setup allows the two ControlByWeb™ products in the above example to be accessed remotely from the Internet.

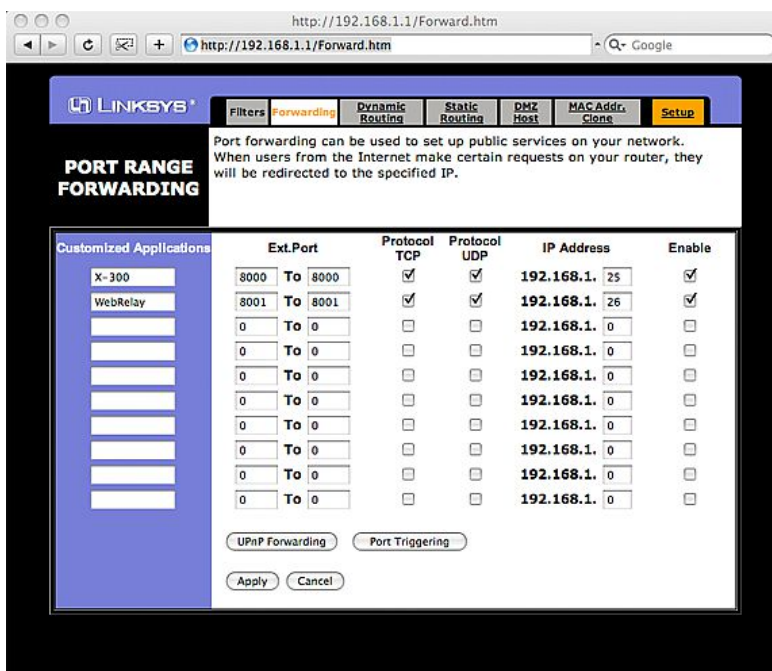

Figure Appendix C.3- Port Range Forwarding

Note: This screen shot is simply an example of a typical router setup page. Routers will vary.

Accessing Setup Pages

After changing ports, the setup pages are accessed on a local network as described below:

```
http://(Local IP Address):(Port Number)/setup.html
```

For example, to access the setup pages when the port is set to 8000, the following command would be used:

```
http://192.168.1.25:8000/setup.html
```

To access the ControlByWeb™ units from the Internet, enter the public IP address of the router plus the port number of the desired device in the following format:

```
http://(Public IP Address of Router):(Port Number of Device)/setup.html
```

Using the example above, the following line would be used to access the setup page of X-320™:

```
http://266.70.164.97:8000/setup.html
```

Appendix D: Log Files

X-320™ logs information to two different log files; log.txt and syslog.txt. Both log files are text files and are stored in nonvolatile memory; this data will not be lost due to power failure and is also not cleared when restoring factory defaults. The log files are stored in circular buffers which write from the beginning of the allocated memory space to the end and then repeat from the beginning (over-writing the original data). The nonvolatile memory is divided into 4K byte sectors. Each time data gets erased to make room for new data, a full sector (4K bytes) is erased at one time.

Data Log File – log.txt

This log file is user-configurable under the **Logging** setup tab, and stores real-world data such as temperatures and events such as I/O state changes (see section **2.4.6 Logging Tab** for more information). It can be up to 512K bytes long and is stored using a comma separated value formatting scheme.

I/Os, Counters, Analog Inputs, Frequency Inputs, and Sensors will only be displayed if they are selected in the **Logging** setup tab. The file is read by requesting the log.txt file from X-320™. For example, using the default IP address the following command would be used to request the log file:

```
http://192.168.1.2/log.txt
```

File Format:

```
MM/DD/YYYY HH:MM:SS, I/O 1, I/O 2, Counters 1-2, Frequency Input, Analog
Inputs 1-4, Sensors 1-6, Source: State
```

Date and Time Format:

MM – Month (1-12)

DD – Day (1-31)

YYYY – Year (1970 - 2106)

HH – Hour in 24 hour time (0 -23)

MM – Minutes (0-59)

SS – Seconds (0-59)

Sample File:

```
Date Time, I1, I2, C1, C2, F, A1, A2, A3, A4, S1, S2, S3, S4, S5, S6, Source
11/15/2010 11:00:46,0,1,1,1,1,0,1,0,1,0,1,1,078.0,076.4,082.7,I/O 1:(on)
11/15/2010 11:00:48,0,0,1,1,1,0,1,0,1,0,1,1,078.0,076.4,082.7,
11/15/2010 11:01:08,0,0,0,0,0,0,1,0,1,0,1,1,078.0,076.5,082.9,
11/15/2010 11:02:04,0,0,0,0,0,1,1,0,1,0,1,1,077.7,076.4,083.4,
```

The file can then be saved using the 'Save As...' option under the 'File' menu of the web browser. If the TCP port has been changed (not port 80), the port will be required to read the file. For example, using the default IP address, and port 8000, the log file would be read as follows:

```
http://192.168.1.2:8000/log.txt
```

The log.txt file may be erased with the following command:

```
http://192.168.1.2/log.txt?erase=1
```

After erasing the file, it might be necessary to refresh the page.

Note: If the Control Password is enabled in the setup pages, the password will be required to access the log file.

System Log File – syslog.txt

The syslog file records various system events, which can be used for diagnostics and troubleshooting purposes.

File Format:

MM/DD/YYYY HH:MM:SS, (category to which message applies): (message)

Sample File:

```
01/02/2010 04:08:13 DEVICE: Power Up.
01/01/2010 00:41:05 DEVICE: Reset factory defaults.
```

Listed below is a description of messages that a user may see:

Category	Message	Description
DEVICE	Power Up	Device has been properly powered.
	Initialize	Device is ready.
	Reset Factory Defaults	Device has been reset to factory defaults.
EMAIL	Failed DNS Lookup	Unable to lookup mail server due to an incorrect DNS setting.
	Bad Username	Email was not sent due to an incorrect user name.
	Bad Password	Email was not sent due to an incorrect password.
	Authentication Required	A user name and password are required by the mail server.
	No Response	No response from SMTP server.
CLOCK	RTC Reset	Real Time Clock has been reset.
NTP SERVER	Request Attempt	Device attempting to connect to NTP Server
	Failed DNS Lookup	Unable to lookup NTP server name due to an incorrect DNS setting.
	Success	Device successfully connected to NTP Server.
REMOTE SERVER	Failed DNS Lookup	Unable to lookup Remote Server due to an incorrect DNS setting.
	Connection Attempt Started	Connection port with Remote Server has been opened.
	Connection Closed	Connection port with the Remote Server has been closed.
DHCP	Address Acquired	IP address request successful, and IP address assigned.
	Lease Renewal	IP address assigned to device was renewed.
MAIN_MCU	New Firmware Loaded	New firmware has been loaded to the device.

This file is read by requesting the syslog.txt file. For example, using the default IP address the following command would be used:

```
http://192.168.1.2/syslog.txt
```

Note: The setup user name and password are required to access this file.

If the TCP port has been changed (not port 80), the port will be required to read the file. For example, using the default IP address, and port 8000, the log file would be read as follows:

```
http://192.168.1.2:8000/syslog.txt
```

To erase the file, use:

```
http://192.168.1.2/syslog.txt?erase=1
```

Appendix E: External Server and Remote Services

Note: The following methods are supported by X-320™; however, Xytronix Research & Design, Inc. does not provide or support custom third party applications, or external web servers.

Accessing X-320™ with Custom Software or Third Party Applications

Custom applications can send commands to X-320™ for monitoring and control functions using XML. (See **3.2 XML Operation** for more information.) The application interface can be used to provide a custom user interface, access to multiple units in a single screen, and allow for automation, logging, and other application-specific features.

Using an External Web Server

Rather than accessing X-320™ directly from a computer, an external web server can be used. The term “external” web server is used here to mean a separate web server (such as Apache or IIS) that is not the web server built into X-320™. In this scenario, users access custom web pages that reside on the external web server and the external web server communicates with X-320™.

An external web server can integrate multiple ControlByWeb products into a single control page. In other words, the user may not be aware that he/she is using multiple ControlByWeb™ devices, but rather the user sees an integrated control page for the entire system. In addition, the use of an external web server allows programmers to create custom user interfaces that take advantage of the additional resources typically available on larger web servers, including more memory and various web programming languages.

There are two approaches that an external server can use to communicate with X-320™ and other ControlByWeb™ devices, Direct Server Control and Remote Services.

Direct Server Control

The first approach is for the external server to create a TCP connection whenever it needs to access X-320™. In this case, the external server opens the connection, sends commands and/or reads the device, and closes the connection.

This method is ideal when the the web server and all of X-320™ devices are on the same network (without routers between them). In this case, the server can communicate with X-320™ devices directly and securely since data never has to leave the local network.

When the server and X-320™ are on different networks, routers must be configured to allow appropriate access. If a public network is used, such as the Internet, security precautions should be considered.

Remote Services

The second approach is for X-320™ to initiate a connection using the “Remote Services.” The settings under the **Advanced Network** tab in the setup pages will enable the X-320™ to open a TCP connection with an external server. Once the connection is open, the external server can send commands and/or read the device. The external server can leave the connection open (so that it never closes) or close the connection.

“Remote Services” is ideal for installations where the server and X-320™ are installed on different networks. This is especially useful when each

X-320™ is installed on a separate private network. For example, if the user doesn't control the network connections where X-320™ is installed, “Remote Services” would initiate a TCP connection over the Internet with the control computer. Since X-320™ initiates the connection, the control computer doesn't have to know the IP address of X-320™. This means that X-320™ can be installed using DHCP. In addition, no special router configuration is required. This makes the network installation of X-320™ very

simple, and since no incoming ports need to be opened in the router, security is not compromised. See section **2.4.3 Advanced Network Tab** for more information.

X-320™ can be configured to establish a connection when triggered by an event, such as a I/O state changing. This is done by setting the Remote Service/SNMP checkbox in the I/O setup tabs.

When an event occurs and a connection is open, the state.xml file is sent.

If a connection is not open and Remote Services is enabled, a connection will be established by sending the connection string. Once the connection is established state.xml will be sent.

Connection String

With Remote Services enabled, a connection attempt will be made periodically according to the Connection Interval setting in the **Advanced Network** setup tab. The Connection String is a user-defined character string configured in the **Advanced Network** tab.

The connection string is also sent at the same interval once the connection is open. The external server is responsible for closing the connection when it is done.

Appendix F: SNMP Requests, Objects and Community Strings

I/O states Frequency Inputs, Analog Inputs, and Temperature/Humidity measured by the X-320™, and some simple network parameters can be retrieved using Simple Network Management Protocol(SNMP). The states of the Outputs can be changed through SNMP requests. For most cases, using SNMP is as simple as locating the appropriate Management Information Bases (MIB) files and loading them into the SNMP manager software. X-320™ can make use of the following MIB files: RFC1213-MIB and XYTRONIX.mib.

Note: As additional ControlByWeb products are introduced, the Xytronix MIB file will remain reverse compatible, older MIB files can be overwritten.

SNMP is configured under the **Advanced Network** setup tab. See section **2.4.3 Advanced Network Tab** for more information.

X-320™ supports the following Packet Data Units (PDU):

- GetRequest
- GetNextRequest
- SetRequest
- Trap

Standard Objects

X-320™ supports several standard RFC1213 objects that usually come with SNMP management software. If not, an Internet search for RFC1213-MIB will turn up multiple links.

RFC1213 Object	Response
system.sysDescr	X-320 DAQ Module
system.sysObjectID	X320
system.sysUpTime	Time in hundredths of seconds since X-320™ was last powered.
system.sysName	X-320*

*The sysName is customizable under the **Control Page Setup** tab.

Xytronix Objects

X-320™ also supports some special objects that can be found in the XYTRONIX.mib. This MIB can be downloaded from our website.

Read Only Objects:**Inputs**

Object	Input Type	Response
x320InputOne	Digital	Value: 0 or 1 (0 – OFF, 1 – ON)
x320InputTwo	Digital	Value: 0 or 1
x320InputThree	Analog (configured as Digital)	Value: 0 or 1
x320InputFour	Analog (configured as Digital)	Value: 0 or 1
x320InputFive	Analog (configured as Digital)	Value: 0 or 1
x320InputSix	Analog (configured as Digital)	Value: 0 or 1

Counters

Scaled values are reported.

Object	Response
x320PulseCounterOne	Value: 0.0 (Current count)
x320PulseCounterTwo	Value: 0.0 (Current count)
x320PulseRateOne	Value: 0.0 (Current rate of count on counter 1)
x320PulseRateTwo	Value: 0.0 (Current rate of count on counter 2)

Frequency Input

Scaled values are reported.

Object	Response
x320Frequency	Value: 0.0 (Current frequency)

Analog Inputs

Scaled values are reported.

Object	Response
x320AnalogOne	Value: 0.0 (Current analog value)
x320AnalogTwo	Value: 0.0 (Current analog value)
x320AnalogThree	Value: 0.0 (Current analog value)
x320AnalogFour	Value: 0.0 (Current analog value)
x320Vin	Value: 0.0 (Current analog value)

Sensors

Object	Response
x320SensorOne	Value: x.x (Decimal temperature or humidity.)
x320SensorTwo	Value: x.x (Decimal temperature or humidity.)
x320SensorThree	Value: x.x (Decimal temperature or humidity.)
x320SensorFour	Value: x.x (Decimal temperature or humidity.)
x320SensorFive	Value: x.x (Decimal temperature or humidity.)
x320SensorSix	Value: x.x (Decimal temperature or humidity.)

Read/Write Objects:

Outputs – Read/Write

A Get request will return the current state. A Set request of 0 or 1 will turn the Output **ON** or **OFF**. A Set request of 2 will pulse the Output for the time configured in the setup page.

Object	Response	Set Value
x320OutputOne	Value: 0 or 1	0 - OFF, 1 - ON, 2 - PULSE
x320OutputTwo	Value: 0 or 1	0 - OFF, 1 - ON, 2 - PULSE

TRAPS

X-320™ can send SNMP messages when an I/O changes state, Frequency Input changes, Analog Input changes, or when a particular Sensor value is reached. The SNMP Trap must be configured for each Digital I/O, Input, and Sensor in the setup pages. The following Traps are supported:

Output Traps

A change in state of the Output will cause the X-320™ to send a Trap message.

Object	Description	Value
X320.75	Relay one state change.	0 or 1 (0 – OFF, 1 – ON)
X320.76	Relay two state change.	0 or 1

Input Traps

When an input on the X-320™ changes state, a Trap message will be sent. Analog inputs may also be configured a logic inputs, three through six.

Object	Description	Value
X320.95	Input one state change.	0 or 1 (0 – OFF, 1 – ON)
X320.96	Input two state change.	0 or 1
X320.97	Input three state change.	0 or 1
X320.98	Input four state change.	0 or 1
X320.99	Input five state change.	0 or 1
X320.100	Input six state change.	0 or 1

Analog Input Traps

Alarm thresholds can be configured for each Analog Input. An SNMP Trap message can be sent when the boundaries are crossed. See section **2.4.9 Analog Tab** for more information on configuring analog input alarms. Trap analog values are given with one decimal place.

Object	Description	Value
X320.120	Analog one alarm	xxx.x
X320.121	Analog two alarm	xxx.x
X320.122	Analog three alarm.	xxx.x
X320.123	Analog four alarm.	xxx.x

Frequency Alarm

Alarm thresholds can be configured for the Frequency Input. An SNMP Trap message can be sent when the boundaries are crossed. See **2.4.8 Frequency Tab** for more information on configuring alarms. Frequency values are shown with 5 decimal places.

Object	Description	Value
X320.150	Frequency one alarm.	xxx.xxxxx

Sensor Traps

Two alarm thresholds can be configured for each sensor. An SNMP Trap message can be sent when the temperature boundaries are crossed. See **2.3.9 Sensor Tab** for more information on configuring the sensor alarms.

Object	Description	Value
X320.65	Sensor one alarm.	xx.x
X320.66	Sensor two alarm.	xx.x
X320.67	Sensor three alarm.	xx.x
X320.68	Sensor four alarm.	xx.x
X320.69	Sensor five alarm.	xx.x
X320.70	Sensor six alarm.	xx.x

Password

X-320™ uses the Control Password for both the read and write community strings. If the Control Password is disabled, any object can be read without the need for a correct community string. By default the Control Password is `webrelay`.

Appendix G: BASIC Scripts

BASIC (Beginners All-purpose Symbolic Instruction Code) is a computer programming language that has been in use for many years. The X-320™ has an integrated BASIC interpreter for simple BASIC scripts. This provides a great deal of flexibility by allowing users to customize basic functions of the unit. The interpreter only supports a small subset of the BASIC commands that are available for computers. Some non-standard commands have been added, and some commands may function differently on the X-320™ BASIC interpreter than on other platforms. The following is a short tutorial on the supported BASIC functions.

Contact customer support if further assistance is required.

Structure

A BASIC script is written as a .txt file, which is then uploaded to the device using the **Script** setup tab. The maximum script size is 2 kbytes. Each line within the script contains a single statement. Line numbers are not used.

Statements are not case sensitive; however, variables are.

IF THEN, FOR loops, and DO loops can only be nested up to 5 times per command. For those not familiar with nesting, the following is an example of nested FOR loops:

```
FOR a = 0 to 100
  FOR b = 0 to 100
  NEXT b
NEXT a
```

Every program must end with an END statement. Subroutines would then follow after the END statement, if required. The last line of the script should be left blank.

Line Format

Every line follows the same format. The basic format is:

statement (variable) (=, <, >, <=, >=, <>) (expression) (THEN)

The fields in parentheses are optional depending on the statement. Spaces must be used between all statements, numbers, variables, operators, expressions, etc. Multiple spaces are valid.

Comments may be inserted, but must begin with an apostrophe. All text on a line after the apostrophe is ignored.

Examples:

```
LET a=1           'this will return an error because of insufficient spacing
LET a = 1        'this is valid
LET a  =  1      'this is valid
```

Only a single variable or literal is allowed on the left side of any operator. The following example is incorrect and

will return an error. The error occurs because there is more than a single value to the left of the comparison operator (a + 2 is to the left of =).

```
IF a + 2 = 3 THEN 'this will return an error
```

To fix the above line, replace 'a + 2'. One of the following options may be used:

```
IF a = 1 THEN
LET b = a + 2

IF b = 3 THEN
```

Supported Statements

The following are the statements supported by the ControlByWeb™ BASIC interpreter.

LET

The LET statement assigns a variable a value. The format is:

```
LET (variable) = (expression)
```

IF THEN, ELSE, END IF

The IF THEN statement tests the truth of a condition. The ELSE statement defines a second function if the condition is found false. In other words, if the condition is true, then a function is performed. If it is not true, a second function may be performed. The second function may or may not be necessary depending on the application. The IF THEN (ELSE) statement must always be followed with an END IF statement. The format is:

```
IF (variable) (=, <, >, <=, >=, <>) (expression) THEN  
  (Function 1)  
ELSE  
  (Function 2)  
END IF
```

Note: In most BASIC interpreters, 'Function 1' (see above) may be placed after the THEN statement. This interpreter requires 'Function 1' to be put on the following line.

FOR TO, NEXT

The FOR TO statement loops a section of code a predefined number of times. The NEXT statement always follows the section of code to be looped. The format is:

```
FOR (variable) = (expression) TO (expression)  
  (code to be looped)  
NEXT (variable)
```

DO WHILE, LOOP

The DO WHILE statement loops a section of code while a condition is found true. The LOOP statement always follows the section of code to be looped. Note that if the condition is omitted, the code will be looped without end. The format is:

```
DO WHILE (variable) (=, <, >, <=, >=, <>) (expression)  
  (code to be looped)  
LOOP
```

Example:

```
let t0 = 100  
do while t0 > 0  
  ' wait  
loop
```

LOG

The LOG statement causes the device to log data according to the settings specified under the **Logging** setup tab.

*Note: In order to log, logging must be enabled in the **Logging** setup tab.*

The format is:

LOG

EMAIL

The EMAIL statement causes the device to send an email of the same format as that generated by other status change and alarm conditions. The event that triggered the email is given, followed by the I/O or Sensor that you want to email. The format is:

EMAIL (feature state – relayX, inputX, tempX) 'X represents the feature number such as relay2

Examples:

```
EMAIL          'Status email sent to addresses listed under Network tab.
...or...
EMAIL relay2 'Sends state change message to emails setup in I/O tab.
...or...
EMAIL input1 'Input state change message to emails setup in I/O tab.
...or...
EMAIL temp2  'Temp alarm message sent to recipients in the Sensors tab.
```

END

The END statement ends the main body of code.

CALL

The CALL statement is found within the main body of code, but requires the interpreter to skip to a subroutine found at the end of the program. After the subroutine is finished, the interpreter returns to the line immediately following the CALL statement. The format is:

CALL (name of subroutine)

SUB, END SUB

The SUB statement defines the beginning and name of a subroutine. The END SUB statement defines the end of the respective subroutine. Subroutine names can be up to 20 characters long and are case sensitive. The SUB and END SUB statements always must follow the END statement. The format is:

```
END

*** Subroutines Go Here ***
SUB (name of subroutine)
  (contents of subroutine)
END SUB

SUB (name of subroutine)
  (contents of subroutine)
END SUB
```

REM or '

The REM or apostrophe (') statement designates remarks made by the programmer. The interpreter will disregard any characters on the line following these statements.

PRINT

The PRINT statement displays a variable or message to the display. The PRINT statement is only available for the PC version of the BASIC interpreter. The device will not recognize the command since it does not have an operator display. The format is:

```
PRINT (variable)      'show variable value to screen
PRINT "(message)"    'show '(message)' to screen
```

User-Defined Variables

Two types of variables are available for use in the ControlByWeb™ BASIC interpreter, user-defined variables, and predefined variables.

Up to 10 user variables may be initialized. These must be single character, lower case letters.

a, b, c, d, e, f, g, h, i, j

They are always global and stored internally as floating point numbers. Variables are defined using the LET statement.

Examples:

```
Let b = 5           'variable b will be set to 5
Let d = b + 2      'variable d will be set to 7
```

Predefined Variables

The following are useful predefined variables for the ControlByWeb™ BASIC interpreter. These are useful for accessing internal values and features states.

Timer Variables

Six timers are available for use in BASIC scripts.

t0, t1, t2, t3, t4, t5

Timers can be set to any positive integer (or 0) by using the LET statement. As soon as a value is assigned to a timer, it will begin to count down immediately by decrementing one count every 100 ms until it reaches zero.

Examples:

```
Let t3 = 1500      'set timer 3 to 150 seconds
Let t1 = 0         'disable time 1
```

Output Variables

Any output pin, whether a relay or digital output, uses a “relay” variable. The following variables are available, depending on the configuration of the digital I/O.

```
relay1           'digital output 1
relay2           'digital output2
rmt_relay1      'remote relay 1
```

rmt_relay2

rmt_relay3

Note: Commands can be sent to remote relays, but the states of those relays cannot be read. Consequently, remote relays should not be used in safety or security-critical applications.

Relay outputs can be turned ON, turned OFF, pulsed, toggled, or read in BASIC scripts. The LET statement is used to set the output state. The state options available are:

0 – turn relay off

1 – turn relay on

2 – pulse relay

5 – toggle relay

The pulse time is specified in the **Output** setup tab. Outputs are designated as relay1, and relay2, which corresponds to Output 1, and Output 2.

Examples:

```
Let relay1 = 1      'turn on output 1
Let relay2 = 0      'turn off output 2
Let relay1 = 2      'pulse output 1
Let relay2 = 5      'toggle output 2
Let a = relay2      'read the state of output 2, state will be 0 or 1
```

Input Variables

The digital input states and analog inputs, when configured in digital mode, can be read in BASIC scripts.

```
input1          'digital input 1
input2          'digital input 2
input3          'analog input 1 in digital mode
input4          'analog input 2 in digital mode
input5          'analog input 3 in digital mode
input6          'analog input 4 in digital mode
```

Example:

```
Let a = input1      'sets 'a' equal to value of input 1
```

Counter Variables

The input counters can be read in BASIC scripts.

```
count1          'input 1 counter
count2          'input 2 counter
count3          'frequency counter
```

Example:

```
If count1 > 5000 Then      'If I/O counter 1 is greater than 5000 then
    Let relay1 = 1          'turn output 2 on
End If
```

Analog Variables

The analog input scaled values can be read in BASIC scripts.

```
ana1          'analog input 1
...           'ana2, ana3
ana4          'analog input 4
```

Example:

```
If anal > 4 Then           'If Analog Input 1 is greater than 4 then
    Let relay1 = 2         'Pulse output 1, otherwise
Else
    Let relay1 = 0         'output1 will be off
End If
```

Temperature/Humidity Sensor Variables

Each temperature sensor or humidity sensor can be read in BASIC scripts.

```
temp1         'temp or humidity sensor 1
temp2         'temp or humidity sensor 2
...           'temp3, temp4, temp5
temp6         'temp or humidity sensor 1
```

Example:

```
If temp2 >= 80 Then       'If temperature sensor reads greater than 80
                           ' degrees, then
    Let relay2 = 1         'Turn on relay 2
End If
```

Date and Time Variables

The variables 'time' and 'date' are predefined, read only variables that store the current date and time. They can be used to schedule events and activities, such as sending emails, reading temperature, or setting Outputs. The date uses the mm/dd/yyyy format. Clock time is formatted as hh:mm:ss (24-hour clock).

Example:

```
If date = 01/01/2014 Then
    If time > 12:30:00 Then
        Let relay2 = 1
        Let relay3 = 0
    End If
End If
```

*Note: Current date and time can only be set in the **Date/Time** tab.*

Event Variables

Data and time variables can be used to execute script events.

Up to five date variables are available.

```
ed1           'event date variable 1
...           'ed2, ed3, ed4
```

ed5 'event date variable 5

The value assigned to event variables should be in the format mm/dd/yyyy. The event date variables store the number of days that have passed since January 1, 1970.

Event time variables may be used in math expressions as well as comparison statements.

Time variables have a similar naming convention.

et1 'event time variable 1

... ' et2, et3, et4

et5 'event time variable 5

Event time variables are declared in the format hh:mm:ss in 24-hour time. The event time variables store the number of seconds from the beginning of the day.

Event date and event time variables of the same number are linked. If the event time variable is incremented more than the number of seconds in a day (86400 seconds), the variable is reset to 0 and the event date variable is incremented by one. For example, if et3 rolls over to zero, ed3 will be incremented.

The following script example demonstrates defining the event variables and comparing it to the current date and time. Assume current time is April 10, 2010 at 1:30 AM and the event should occur in one hour and every hour thereafter.

Example:

```

Let a = 1
Let ed1 = 04/10/2010           'sets the event date to April 10,
                               '2010.
Let et1 = 02:30:00           'sets the event time to 2:30
Do While a <> 0
  If ed1 >= date Then         'Tests event date versus current date.
    If et1 >= time Then       'Tests event time versus current time.
      Let et1 = et1 + 3600    'Increments the event time by one hour
                              '(in seconds).
      Print "Event"          'Event to occur
    End If
  End If
Loop
End

```

External Variables

External variables are similar to general purpose variables and can be used in the same manner. The difference between general purpose variables and external variables is that external variables can be accessed by the user through a web browser and modified while the script is running. Scripts can use external variables as a method of retrieving user input.

extvar0 'external variable 0

... 'extvar1, extvar2

extvar3 'external variable 3

The following example demonstrates this by creating a script that will turn Output 1 **ON** if extvar1 equals 1 and turn Output 1 **OFF** if extvar1 equals 0.

Example:

```

Do
  If extvar1 = 1 Then
    Let rmt_relay1 = 1
  Else
    Let rmt_relay1 = 0
  End If
Loop
End

```

External variables can also be used to show numeric values, such as a count down timer. If the extVar is any other value than 1 or 0, the value will be displayed in the Status 2 column, with a gray background. See section **2.4.13 Script Tab** for instructions on configuring external variables for visibility on the **Control Page**.

The following code will show a count down from 10 seconds and automatically restart. The refresh rate must be configured in the **Control Page Setup** in order to see each of the count down values.

Example:

```

let t0 = 10                                'Initialize variables and start timer
let extvar0 = 10

'Main Loop
Do
  if t0 = 0                                'when timer reaches 0 decrement counter
    let extvar0 = extvar0 - 1
    let t0 = 10
  end if

  if extvar0 < 0                            'restart when counter reaches zero
    let extvar0 = 10
  end if

loop
end

```

Extvar1 can be set and cleared by entering the following requests into a web browser or by configuring on and off buttons to appear on the **Control Page** for extvar0:

```

http://192.168.1.2/state.xml?extvar1=1
http://192.168.1.2/state.xml?extvar1=0

```

Testing and Debugging

A copy of the BASIC interpreter for Windows is also available on our website for the use of testing and debugging. The X-320™ will only acknowledge errors as it runs. This means that if a path of the script is not encountered, errors may still exist. The Windows version of the interpreter, however, will check for errors before the script is run.

The PRINT function is available for use with the Windows version of the BASIC interpreter. The interpreter on the device, however, will not recognize this command.

Note: The script will be restarted by submitting any of the setup pages or by power cycling the unit.

MISSING END OF LINE error may be caused by misspelled names or a program that is too long. 1900 bytes of memory is reserved for BASIC scripts. Each text character, space, punctuation mark, tab, or carriage return uses one byte. If the script is too long, the script will be truncated and will not function as desired.

Appendix H: Modbus Details

Additional Modbus details are provided in this section regarding packet structure and field data. Basic Modbus information is contained in **3.4 Modbus Operation**.

Read Coils - Modbus Function Code 01 (0x01)

This function returns the state of the Digital I/O when they are configured as outputs. 0 denotes that the output is **OFF**, 1 denotes that the output is **ON**.

Request

Valid starting address can fall in the range of 0x0000 and 0x0001. Output 1 is at address 0x0000, and Output 2 is at address 0x0001. Both Outputs may be read at the same time by specifying the correct starting address and quantity of coils to be read.

Start Address: 0x0000 (coil 1) to 0x0001 (coil 2)

Coil Quantity: 0x0001 (1 coil) to 0x0002 (2 coils)

The sum of the start address and coil count cannot exceed the maximum coil count or an error response will be returned.

Modbus TCP Request Frame Example – Read Coils 1 through 2			
Field Name	Length	Function	Example Data
Transaction Identifier	2 bytes	Synchronization number.	0x0001
Protocol Identifier	2 bytes	Zero for Modbus/TCP	0x0000
Message Length	2 bytes	Number of bytes in frame (below)	0x0006
Unit Identifier	1 byte	Slave Address (0xFF if not used)	0xFF
Function Code	1 byte	Read Coils	0x01
Data	4 bytes	Start Address (0x0000-0x0001) Quantity of coils to read (0x0001-0x0002)	0x0000 0x0002

Tx String: 00 01 00 00 00 06 FF 01 00 01 00 02

Response

The X-320™ will respond to the request with a data field of one byte, each bit representing the coil status. A 1 indicates the Output is **ON**. A 0 indicates that the Output is **OFF**.

Bit zero of the return value will be the state of the coil corresponding to the start address. For example, if a start address of 0x0001 is used, bit zero will be the status of Output 2.

Coil State Byte							
Bit 7	6	5	4	3	2	1	Bit 0
X	X	X	X	X	X	Output 2	Output 1

Possible values for a start address of 0x0000 are:

Data Byte (hex)	Data Byte (binary)	Input 2 State	Input 1 State
0x00	0000	OFF	OFF
0x01	0001	OFF	ON
0x02	0010	ON	OFF
0x03	0011	ON	ON

If neither of the I/Os are configured as outputs, the request will return 0x00 for the status byte.

X-320™ Response Frame Example – Status of Output 1 and Output 2			
Field Name	Length	Function	Example Data
Transaction Identifier	2 bytes	Synchronization number.	0x0001
Protocol Identifier	2 bytes	Zero for Modbus/TCP	0x0000
Message Length	2 bytes	Number of bytes in frame (below)	0x0004
Unit Identifier	1 byte	Slave Address (0xFF if not used)	0xFF
Function Code	1 byte	Read Coils	0x01
Data	2 bytes	Byte Count (0x01) Coil status (0x00 to 0x03)	0x01 0x03

RX String: 00 01 00 00 00 06 FF 01 01 03

Errors

The following are possible error responses for function code 0x01.

Coil Read Error Function Code (1 byte): 0x81

Exception Codes (1 byte): 0x01 – Function code not supported.

0x02 – Incorrect combination of start address and quantity of Outputs

Error Response Frame Example			
Field Name	Length	Function	Example Data
Transaction Identifier	2 bytes	Synchronization between messages of server and client.	0x0001
Protocol Identifier	2 bytes	Zero for Modbus/TCP	0x0000
Message Length	2 bytes	Number of bytes in frame (below)	0x0003
Unit Identifier	1 byte	Slave Address (0xFF if not used)	0xFF
Function Code	1 byte	Function code	0x81
Data	1 byte	Exception code (0x01 - 0x02)	0x02

Rx String: 00 01 00 00 00 03 FF 81 02

Read Discrete Inputs – Modbus Function Code 02 (0x02)

X-320™ has two types of discrete inputs, Digital I/O and Analog input.

The Digital I/O must be configured as inputs under the **Digital I/O** tab. The switching thresholds are fixed.

Analog inputs may also be configured as digital inputs. These are configured in the **Analog** tab. The voltage level at which the inputs switch between high and low can be configured. Please refer to the **Analog** tab for more information.

This function returns the state of the discrete inputs.

Start Address: 0x0000 (input1) to 0x0005 (Analog Input 4)

Input Quantity: 0x0001 to 0x0006

The sum of the starting address and the quantity of coils must not be greater than 0x0006. For example, if you want to read 0x0002, both inputs, then the start address must be 0x0000. To read the second input only the start address is 0x0001 with a quantity of 0x0001.

Request

Modbus TCP Request Frame Example – Read Inputs 1 - 2			
Field Name	Length	Function	Example Data
Transaction Identifier	2 bytes	Synchronization number.	0x0001
Protocol Identifier	2 bytes	Zero for Modbus/TCP	0x0000
Message Length	2 bytes	Number of bytes in frame (below)	0x0006
Unit Identifier	1 byte	Slave Address (0xFF if not used)	0xFF
Function Code	1 byte	Read Inputs	0x02
Data	4 bytes	Start Address (0x0000-0x0001) Quantity (0x0001-0x0006)	0x0000 0x0002

TX String: 00 01 00 00 00 06 FF 02 00 00 00 02

Response

The inputs states are indicated by bits one and two of the status byte. A 1 indicates that the input is switched high (**ON**). A 0 indicates that the input switched low (**OFF**). Pull-up and pull-down resistor settings are valid logic input levels. **ON** will show when the internal pull-up is enabled and the input is open. **OFF** will be read when the internal pull-down is enabled and the input is open.

Bit zero of the return value will be the state of the coil corresponding to the start address. For example, if a start address of 0x0001 is used, bit zero will be the status of input 2.

Note: If neither Digital I/O is configured as an input, the response will show the value of the internal pull resistors.

Possible values for a start address of 0x0000 are:

Discrete Input State Byte							
Bit 7	6	5	4	3	2	1	Bit 0
X	X	Analog Input 4	Analog Input 3	Analog Input 2	Analog Input 1	Input 2	Input 1

X-320™ Response Frame Example – Inputs 1 and 2 ON			
Field Name	Length	Function	Example Data
Transaction Identifier	2 bytes	Synchronization number.	0x0001
Protocol Identifier	2 bytes	Zero for Modbus/TCP	0x0000
Message Length	2 bytes	Number of bytes in frame (below)	0x0006
Unit Identifier	1 byte	Slave Address (0xFF if not used)	0xFF
Function Code	1 byte	Read Inputs	0x02
Data	2 bytes	Byte count (0x01) Input State (0x00-0x03)	0x01 0x03

RX String: 00 01 00 00 00 04 FF 02 01 03

Errors

Input Read Error Function Code (1 Byte): 0x82

Exception codes (1 Byte): 0x01 – Function not supported.

0x02 – Incorrect combination of start address and input quantity.

Error Response Frame Example			
Field Name	Length	Function	Example Data
Transaction Identifier	2 bytes	Synchronization between messages of server and client.	0x0001
Protocol Identifier	2 bytes	Zero for Modbus/TCP	0x0000
Message Length	2 bytes	Number of bytes in frame (below)	0x0003
Unit Identifier	1 byte	Slave Address (0xFF if not used)	0xFF
Function Code	1 byte	Error code	0x82
Data	1 byte	Exception code (0x01 - 0x02)	0x02

Rx String: 00 01 00 00 00 03 FF 82 02

Read Sensors – Modbus Function Code 03 (0x03)

The Read Holding Registers function is used for the counters, frequency input, analog inputs, and temperature and humidity sensors.

32-bit sensor values are read from 16-bit register pairs. Consequently, sensors addresses and registers must be even numbers.

Analog Input Start Addresses

Input #	Address
1	0x0010
2	0x0012
3	0x0014
4	0x0016

Temperature and Humidity Sensor Start Addresses

Sensor #	Address
1	0x0110
2	0x0112
3	0x0114
4	0x0116
5	0x0118
6	0x011A

Counter Input Start Addresses

Counter #	Address
1	0x0210
2	0x0212

Frequency Input Start Address

Input #	Address
1	0x0214

Request

Modbus TCP Request Frame Example – Read Sensors, Analog, Counters, Frequency Inputs			
Field Name	Length	Function	Example Data
Transaction Identifier	2 bytes	Synchronization number.	0x0001
Protocol Identifier	2 bytes	Zero for Modbus/TCP	0x0000
Message Length	2 bytes	Number of bytes in frame (below)	0x0006
Unit Identifier	1 byte	Slave Address (0xFF if not used)	0xFF
Function Code	1 byte	Read Multiple Registers	0x03
Data	4 bytes	Start Addresses Analog Input (0x0010-0x0016) Temp/RH (0x0110-0x011A) Counter (0x0210-0x0212) Frequency (0x0214) Quantity (0x0002-0x000C)	0x0010 0x0004

TX String: 00 01 00 00 00 06 FF 03 00 10 00 04

Response

The X-320™ may be configured for little-endian (default) or big-endian transmission (see Advanced Network tab for more information). With little-endian ordering, a temperature reading of sensor 1 (0x0110) would return 0x800042A2. The least significant word would be 8000 hex and the most significant word would be 42A2. This hexadecimal value converts to a temperature reading of 81.25 degrees.

If a temperature or humidity sensor is not installed, a value of 0xFFFFFFFF (NaN) is returned. Other inputs will show measured values of the open circuits.

Modbus TCP Request Frame Example – Read Sensor 1 and 2			
Field Name	Length	Function	Example Data
Transaction Identifier	2 bytes	Synchronization number.	0x0001
Protocol Identifier	2 bytes	Zero for Modbus/TCP	0x0000
Message Length	2 bytes	Number of bytes in frame (below)	0x000B
Unit Identifier	1 byte	Slave Address (0xFF if not used)	0xFF
Function Code	1 byte	Read Sensors	0x03
Data	5-13 bytes	Byte Count: (0x04-0x18) Value: (0x00000000-0xFFFFFFFF)	0x08 0x96274053 0x95314053

Rx:00 01 00 00 00 0B FF 03 08 96 27 40 53 95 31 40 53

Errors

Sensor Read Error Function Code (1 byte): 0x83

Exception Codes (1 byte): 0x01 – Function not supported.

0x02 – Incorrect combination of start address and input quantity

Error Response Frame Example			
Field Name	Length	Function	Example Data
Transaction Identifier	2 bytes	Synchronization between messages of server and client.	0x0001
Protocol Identifier	2 bytes	Zero for Modbus/TCP	0x0000
Message Length	2 bytes	Number of bytes in frame (below)	0x0003
Unit Identifier	1 byte	Slave Address (0xFF if not used)	0xFF
Function Code	1 byte	Error code	0x83
Data	1 byte	Exception code (0x01 - 0x02)	0x02

RX String: 00 01 00 00 00 03 FF 83 02

Write Single Coil – Modbus Function Code 05 (0x05)

This function allows you to control the Outputs one at a time, if the I/O is configured as an output.

Output Address (2 bytes): 0x0000 (Output 1) – 0x00001 (Output 2)

Output Value (1 byte): 0x00 (OFF), 0xFF(ON)

Padding (1 byte): 0x00

Request

Modbus TCP Request Frame Example – Write Coil 2 ON			
Field Name	Length	Function	Example Data
Transaction Identifier	2 bytes	Synchronization number.	0x0001
Protocol Identifier	2 bytes	Zero for Modbus/TCP	0x0000
Message Length	2 bytes	Number of bytes in frame (below)	0x0006
Unit Identifier	1 byte	Slave Address (0xFF if not used)	0xFF
Function Code	1 byte	Write Coil	0x05
Data	4 bytes	Output address (0x0000 – 0x0001) Output value (0x00, 0xFF) Padding (0x00)	0x0001 0xFF 0x00

Tx String: 00 01 00 00 00 06 FF 05 00 01 FF 00

Response

X-320™ Response Frame Example – Write Coil 2 ON			
Field Name	Length	Function	Example Data
Transaction Identifier	2 bytes	Synchronization number.	0x0001
Protocol Identifier	2 bytes	Zero for Modbus/TCP	0x0000
Message Length	2 bytes	Number of bytes in frame (below)	0x0006
Unit Identifier	1 byte	Slave Address (0xFF if not used)	0xFF
Function Code	1 byte	Write coil	0x05
Data	4 bytes	Output address (0x0000 - 0x0001) Output value (0xFF, 0x00) Padding (0x00)	0x0001 0xFF 0x00

Rx String: 00 01 00 00 00 06 FF 05 00 01 FF 00

Errors

Single Coil Write Error Function Code (1 Byte): 0x85

Exception codes (1 Byte): 0x01 – Function not supported.

0x02 – Address out of range.

0x03 – Padding value.

An error will not be returned if I/O pin is configured as an input instead of an output.

Error Response Frame Example			
Field Name	Length	Function	Example Data
Transaction Identifier	2 bytes	Synchronization between messages of server and client.	0x0001
Protocol Identifier	2 bytes	Zero for Modbus/TCP	0x0000
Message Length	2 bytes	Number of bytes in frame (below)	0x0003
Unit Identifier	1 byte	Slave Address (0xFF if not used)	0xFF
Function Code	1 byte	Error code	0x85
Data	1 byte	Exception code (0x01-0x03)	0x03

RX String: 00 01 00 00 00 03 FF 85 03

Write Multiple Coils - Modbus Function Code 15 (0x0F)

One byte can be written to set the state of both Outputs, each bit representing one Output.

Start Address (2 bytes): 0x0000 (Output 1) – 0x0001 (Output 2)

Output Quantity (2 bytes): 0x0001 – 0x0002

Byte Count (1-2 bytes): 0x01

Output Value (1-2 bytes): 0x0000 – 0x0003

Output State Byte							
Bit 7	6	5	4	3	2	1	Bit 0
X	X	X	X	X	X	Output 2	Output 1

Request

Output states are controlled by specifying the start address of the first Output to be controlled, the count of the Outputs to be affected, and the Output state byte.

Modbus TCP Request Frame Example – Write Coils 1 ON, 2 OFF			
Field Name	Length	Function	Example Data
Transaction Identifier	2 bytes	Synchronization number.	0x0001
Protocol Identifier	2 bytes	Zero for Modbus/TCP	0x0000
Message Length	2 bytes	Number of bytes in frame (below)	0x0009
Unit Identifier	1 byte	Slave Address (0xFF if not used)	0xFF
Function Code	1 byte	Write Multiple Coils	0x0F
Data	8-9 bytes	Start address (0x0000 – 0x0001) Output quantity (0x0001 - 0x0002) Byte count (0x01) Byte value (0x00 – 0x03)	0x0000 0x0002 0x01 0x01

TX String: 00 01 00 00 00 09 FF 0F 00 00 00 02 01 01

An output value of 0xFFFF would be used to turn **ON** both of the Outputs in the range or 0x0000 to turn them **OFF**. In the above example, the output value 0xFF would turn Outputs 1-2 **ON**.

Response

X-320™ Response Frame Example – Write Coils 1-2 ON			
Field Name	Length	Function	Example Data
Transaction Identifier	2 bytes	Synchronization number.	0x0001
Protocol Identifier	2 bytes	Zero for Modbus/TCP	0x0000
Message Length	2 bytes	Number of bytes in frame (below)	0x0004
Unit Identifier	1 byte	Slave Address (0xFF if not used)	0xFF
Function Code	1 byte	Write Multiple Coils	0x0F
Data	4 bytes	Start address (0x0000 – 0x0001) Output count (0x0001)	0x0000 0x0001

RX String: 00 01 00 00 00 06 FF 0F 00 00 00 01

Errors

Multiple Coil Write Error Function Code (1 Byte): 0x8F

Exception codes (1 Byte):

- 0x01 – Function not supported.
- 0x02 – Incorrect combination of start address and Output quantity
- 0x03 – Byte count out of range.

No error message is not returned when setting I/O pins that are configured as inputs.

Error Response Frame Example			
Field Name	Length	Function	Example Data
Transaction Identifier	2 bytes	Synchronization between messages of server and client.	0x0001
Protocol Identifier	2 bytes	Zero for Modbus/TCP	0x0000
Message Length	2 bytes	Number of bytes in frame (below)	0x0003
Unit Identifier	1 byte	Slave Address (0xFF if not used)	0xFF
Function Code	1 byte	Error code	0x8F
Data	1 byte	Exception code (0x01 - 0x02)	0x02

Rx String: 00 01 00 00 00 03 FF 8F 03

Write Multiple Registers – Modbus Function Code 16 (0x10)

Function 16 may be used for pre-loading or resetting counters or for pulsing outputs. Two different data formats are used for these functions.

Set Counter

The values for Counters 1 and 2 can be set to a specified whole number (integer) value. This may be necessary when recovering from a system error or when using the counters for a specific measurement. The counter value is stored as an integer (whole number). The multiplier and offset are applied to the stored value to create the Scaled Value. The scaled value is displayed on the control page.

Pulse Outputs

The Modbus Write Multiple Registers function is used to pulse the Output(s) for a specified time. When X-320™ receives this command, it immediately turns the appropriate Output(s) **ON** (if not already on) and starts the pulse timer. The Output(s) are selected by writing the pulse time in seconds to the register(s) associated with the appropriate Output(s).

The pulse time is specified using floating point format in the register value field and can range from 0.1 seconds to 86400 seconds (1 day). When the pulse time expires, the Output will be turned **OFF**. If a pulse time command is sent with a value greater than 86400, the pulse timer will be set to 86400. If a pulse time command is sent with a value less than 0.1, the pulse timer will be set to 0.1.

If any commands are sent to X-320™ (Modbus, xml, or html) before the pulse timer has expired, the pulse timer will be canceled immediately and the new command will be executed.

IEEE 754 floating point format is used for the pulse time. X-320™ may be configured for little-endian (default) or big-endian transmission. The endian-ness is configured in the **Advanced Network** tab, see **2.4.3 Advanced Network Tab** for more information.

Request

Set Counters

The counter value is specified using a 32-bit integer (not a floating point number).

Start Address (2 bytes):	0x0210 (counter 1) - 0x0212 (counter 2)
Register Quantity (2 bytes):	0x0002 - 0x0004 (2 registers for each counter, even number)
Byte Count (1 byte):	0x04 - 0x08 (Multiples of 4)
Counter Quantity (4 bytes/Counter):	0x00000000 – 0xFFFFFFFF (Integer)

Pulse Outputs

Pulse Coil Function Code (1 byte):	0x10
Start Address (2 bytes):	0x0310 (output 1) – 0x0312 (output 2)
Register Quantity (2 bytes):	0x0002 – 0x0004 (2 registers for each Output, even number)
Byte Count (1 byte):	0x04 – 0x08 (Multiples of 4)
Pulse Duration (4 bytes, per Output):	0x3DCCCCC – 0x47A8C000 (big-endian) 0xCCCC3DCC – 0xC00047A8 (little-endian - default)

In the example shown below, the Output will pulse for 10 seconds. Ten seconds is represented using a floating point number of 41200000. It is transferred as 00004120, using little-endian.

Modbus TCP Request Frame Example – Pulse Coil 1 for 10 s			
Field Name	Length	Function	Example Data
Transaction Identifier	2 bytes	Synchronization number.	0x0001
Protocol Identifier	2 bytes	Zero for Modbus/TCP	0x0000
Message Length	2 bytes	Number of bytes in frame (below)	0x000B
Unit Identifier	1 byte	Slave Address (0xFF if not used)	0xFF
Function Code	1 byte	Pulse Coils (Write Multiple Registers)	0x10
Data	9-13 bytes	Start address (0x0310 – 0x0312) Register quantity (0x0002 – 0x0004) Byte count (0x04 - 0x08) Pulse Duration (0xCCCC3DCC – 0xC00047A8)	0x0310 0x0002 0x04 0x00004120

Tx String: 00 01 00 00 00 0B FF 10 00 10 00 02 04 00 00 41 20

Response

X-320™ Response Frame Example – Write Coils 1-2 ON			
Field Name	Length	Function	Example Data
Transaction Identifier	2 bytes	Synchronization number.	0x0001
Protocol Identifier	2 bytes	Zero for Modbus/TCP	0x0000
Message Length	2 bytes	Number of bytes in frame (below)	0x0004
Unit Identifier	1 byte	Slave Address (0xFF if not used)	0xFF
Function Code	1 byte	Write Multiple Coils	0x0F
Data		Start address (0x0000 – 0x0001) Output count (0x0001 – 0x0002)	0x0000 0x0002

Rx String: 00 01 00 00 00 04 FF 10 00 00 00 02

Errors

Pulse Function code Error (1 Byte): 0x90

Exception codes (1 Byte): 0x01 – Feature not supported.

0x02 – Address quantity not an even number.

Incorrect combination of start address and Output count.

Error Response Frame Example			
Field Name	Length	Function	Example Data
Transaction Identifier	2 bytes	Synchronization between messages of server and client.	0x0001
Protocol Identifier	2 bytes	Zero for Modbus/TCP	0x0000
Message Length	2 bytes	Number of bytes in frame (below)	0x0003
Unit Identifier	1 byte	Slave Address (0xFF if not used)	0xFF
Function Code	1 byte	Error code	0x90
Data	1 byte	Exception code (0x01 - 0x02)	0x02

Rx String: 00 01 00 00 00 03 FF 90 02

Appendix I: Specifications

Power Requirements

- Input Voltage: 9-28 VDC
- Current: See table below for typical values at 25°C.

10 Mbps Network Speed

Power Supply	Digital Outputs		Digital Inputs w/ Pull Resistors	
	All Off	All On	Pull-up	Pull-down
9 VDC	160 mA	182 mA	179 mA	160 mA
12 VDC	121 mA	136 mA	136 mA	121 mA
24 VDC	66 mA	74 mA	73 mA	66 mA

100 Mbps Network Speed

Power Supply	Digital Outputs		Digital Inputs w/ Pull Resistors	
	All Off	All On	Pull-up	Pull-down
9 VDC	269 mA	288 mA	290 mA	269 mA
12 VDC	203 mA	219 mA	219 mA	202 mA
24 VDC	107 mA	114 mA	115 mA	107 mA

I/O Connector

- 14-position, removable terminal strip, 3.81 mm spacing
(Replacement part number, Phoenix Contact 1803691)

Digital Inputs/Outputs

- Programmable I/O (2)
- Transient over-voltage protection

Input Mode

- Discrete Inputs (connect to dry contacts)
- Configurable debounce, 0 to 65535 ms
- Pulse Counter, 32-bit (25 Hz-max)
- 5 V_{max} Input
- 47 kohm Programmable 5 V pull-up/pull-down resistor
- Schmitt trigger input (> 0.7 V hysteresis)
- 2.7 V_{low-high} (typical)
- 1.8 V_{high-low} (typical)

Output Mode

- Logic output to external controllers
- 5 V_{high} through 49.9 Ohm resistor

Pulse Counters

- See Digital Input Mode
- 2 second average

- 0.5 Hz read rate

Frequency Input

- 0-130 kHz input frequency
- AC or DC input, 20 V peak to peak
- Sine or square wave (Triangle wave, add approximately 10% to Min Vin)
- 2 second average
- 0.5 Hz read rate
- Auto-zero, positive slope detection
- Accuracy and minimum input level over 24 hrs:

Input Frequency	Min Vin	Read Error
1 to 2 Hz	90 mV	+/-0.5 Hz
2 to 200 Hz	60 mV	+/-0.1 Hz
200 Hz to 1000 Hz	60 mV	+/-1 Hz
1 kHz to 10 kHz	60 mV	+/-1.5 Hz
10 kHz to 50 kHz	60 mV	+1/-2 Hz
50 kHz to 100 kHz	60 mV	+1/-6 Hz
100 kHz to 130 kHz	60 mV	+2/-16 Hz

Analog Inputs

- 4 Channels (configurable as 4 single-ended, 2 differential, or a combination)
- 0 to 5 V input, full scale
- 10 µV resolution
- ±0.02% + 20 uV full scale single-ended mode
- 151 ms read time, sequential read of each channel

Temperature/Humidity Sensors

- 6 Sensor maximum
- 600 ft (180 m) maximum combined cable length

Temperature Sensors

- “1-Wire” Digital Thermometer (Dallas Semiconductor DS18B20)
- +/-0.5°C from -10°C to +85°C

Humidity Sensors

- “1-Wire” Digital Sensor
- 0-100% RH +/- 1.8%

Network

- 10 Base-T or 100 Base-T Ethernet IPv4
- Static IP address assignment or DHCP
- HTTP port selectable
- Standard 8-pin RJ-45 Modular Socket
- Supports Web Browser (HTTP), XML, Modbus/TCP, SNMP protocols

5 LED Indicators

- Power On
- I/O (1-2)
- Network Linked
- Network Activity

Real-Time Clock

- Manual or NTP (Network Time Protocol) setup
- NTP Sync Configurable for Once, Daily, Weekly, or On Power-up
- Automatic Daylight Savings Adjustment
- Battery (capacitor) Power Backup

Capacitor Power Backup

- Supports Real-Time Clock, External Variables, Output State
- 3 days Minimum Duration

Nonvolatile Memory

- Flash Memory
- All user settings are stored in nonvolatile memory. Settings will not be lost when power is disconnected.

Environmental

- Operating Temperature: -40°C to 65.5°C (-40°F to 150°F)
- Storage Temperature: -40°C to 85°C (-40°F to 185°F)

Mechanical

- Size: 1.41 x 3.88 x 3.1 in. (35.7 x 98.5 x 78 mm), connector not included
- Weight: 4.8 oz (136 g)

Logging

- Stored in Nonvolatile Flash
- Circular Buffer
- 512 kB (Up to 42000 log entries)
- Unlimited data storage possible through web services.

Password Settings

- Password protection on Setup Page
- Optional Password protection on **Control Page**
- Base 64 Password Encoding
- 13 Character, Case-Sensitive Password Length

Electromagnetic Compliance

- IEC CISPR 22, CISPR 24
- FCC 47CFR15 (Class B)
- EU EN55024, EN55022

Product Safety Compliance

UL 61010-1 (Electrical Equipment for Measurement, Control, and Laboratory Use)



Appendix J: Mechanical Information

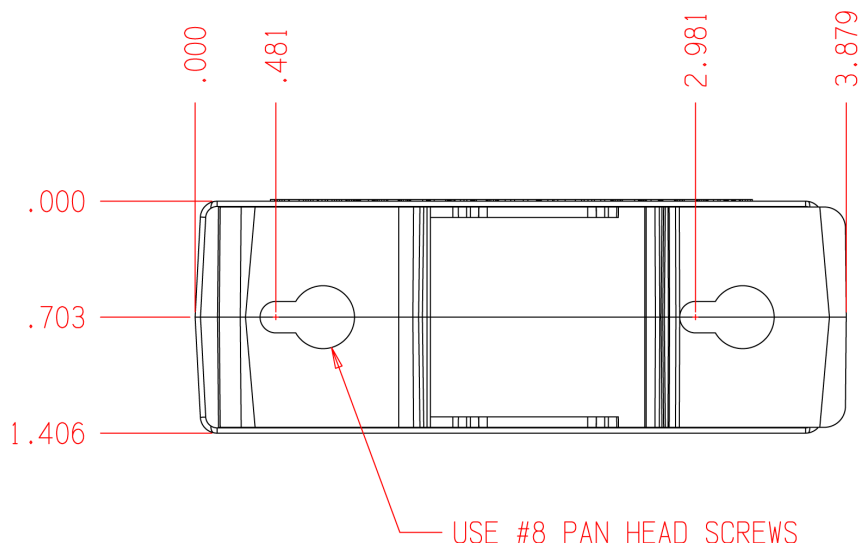
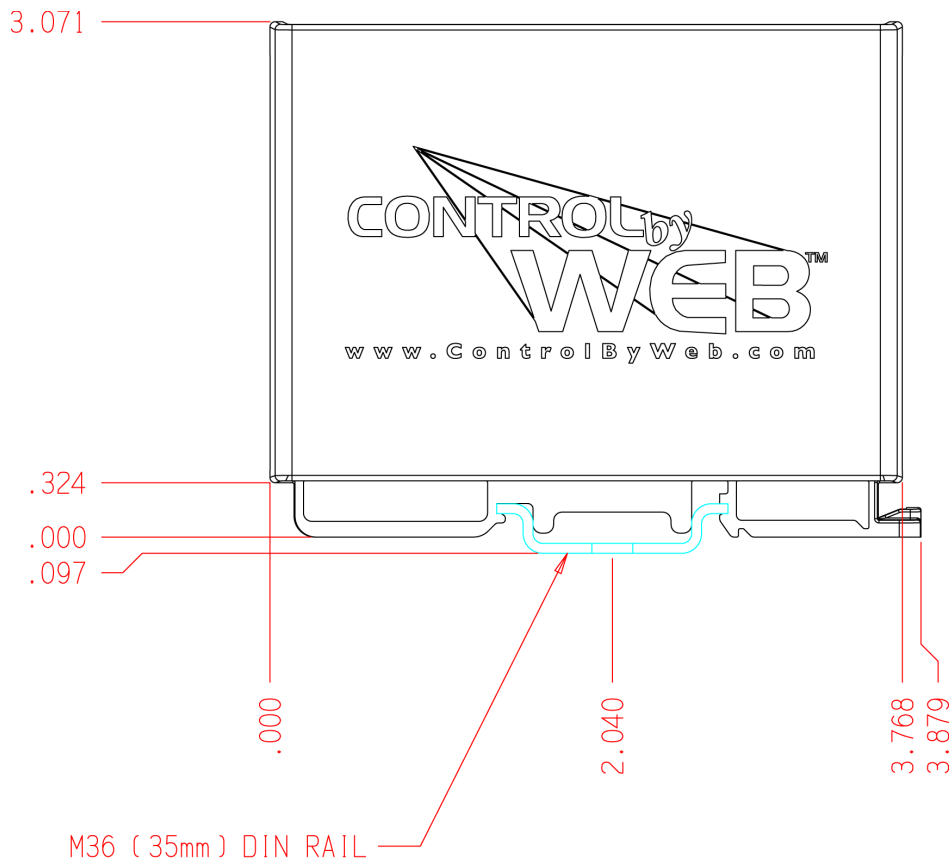

Alphabetical Index

I		
1-Wire.....	151	
10 Base-T.....	25	
10/100 Base-T.....	25	
A		
Advanced Network Tab.....	37	
Alarm.....		
Analog.....	66	
Frequency.....	60	
Temperature.....	77	
Analog.....	64	
Analog Mode.....	65, 72	
Applications.....	11	
Arp.....	26, 27	
Auto Calculate.....	66, 72	
B		
Base64.....	100	
BASIC Scripts.....	128	
C		
Cat 5.....	24	
Color coded.....	82	
Connection.....		
Analog.....	19	
Frequency.....	23	
Input Connection.....	18	
Network.....	25	
Output Connection.....	19	
Power Supply.....	17	
Sensor.....	23	
Control Page Setup Tab.....	90	
Control Password.....	41	
Count.....		
Maximum.....	52	
Maximum.....	52	
Counter.....		
Frequency.....	10, 23, 48, 59, 151	
Counter Offset.....	53	
Counter Slope.....	52	
Crossover.....	25	
Current.....	150	
D		
Date/Time Tab.....	43	
Daylight Savings.....	46	
Deadband.....	77	
Default.....		
IP address.....	31, 92, 100, 112, 114, 120	
Password.....	31, 100	
Username.....	31, 41	
DHCP.....	34, 36	
Digital I/O Tab.....	50	
DIN-Rail.....	15	
DNS Server.....	34	
DS18B20.....	151	
E		
Email Notification.....	111	
Email Option.....	58, 78	
Ethernet.....	13, 14, 25, 35	
Ethernet.....		
Speed.....	34	
Events Scheduler Tab.....	82	
External Server.....	122	
External Variables.....	94	
F		
Factory Default.....	113	
Firmware.....	114	
Full Duplex.....	35	
G		
Gateway.....	26, 34	
GET.....	40, 96, 100	
H		
HTTP Port.....	34	
Humidity.....	12, 23	
I		
Input.....		
Frequency.....	23, 48	
Pulse Counter Options.....	51	
Installation.....	15	
IP address.....	34, 121	
IP Addresses.....	116	
L		
Linux.....	27	
Local Area Network.....	116	
Log Files.....	120	
Logging Tab.....	47	
M		
MAC address.....	26, 27, 32	
Mac OS.....	27	
Mail Server Port.....	35	
Main Tab.....	31	
Manual Time Configuration.....	44	
Modbus.....		

Enabled.....	37	Scaled Value.....	52, 60, 65, 71
Port.....	38	Schedule.....	82, 100
Modbus Operation.....	102	Script Tab.....	87
Modbus/TCP.....	37	Scripts.....	128
Models.....	12	Security.....	8, 39, 40, 41, 122, 123
N		Sensor.....	12
Network.....		Alarm 1.....	77, 78
LAN.....	116	Alarm 2.....	77, 78
Setup.....	26	Cable.....	24, 25
WAN.....	117	Cable lengths.....	24
Network Tab.....	33	Deadband.....	77
NTP.....	34	Sensor Tab.....	76
NTP Time Configuration.....	44	Sensor Trigger.....	49
O		Serial number.....	26
One-wire.....	23	Setup Password.....	41
One-wire data bus.....	23	Slope (Multiplier).....	52, 53, 60, 65, 71
P		SNMP.....	38, 40, 49, 58, 69, 124
Password.....	35, 41	Enabled.....	38
Default.....	31, 41, 42, 127	TRAPS.....	126
Password Tab.....	41	SNMP Requests.....	124
Period.....	45, 48, 82, 84	Specifications.....	150
Ping.....	26, 27	State.XML.....	95
PLC.....	103	Subnet Mask.....	34
Port.....	38	T	
Port Forwarding.....	118	Temperature.....	12, 23
Power.....		Time.....	
Backup.....	152	Date.....	44
Current rating.....	17	Daylight Savings.....	46
Ethernet.....	152	Format.....	44
Indicator.....	13	Manual Time Configuration.....	44
Power Requirements.....	150	NTP Time Configuration.....	44
Power Supply.....	17	Set Time.....	43
Pulse Counter Options.....	51	U	
R		User Name.....	35
Read Coils.....	105, 136	Username.....	31
Read Discrete Inputs.....	106, 138	Default.....	31, 42
Read Sensors.....	107, 140	UTC Offset.....	46
Refresh.....	90	W	
Remote relay.....	10, 55, 62, 68, 73, 79, 80, 131	Warranty.....	6
Remote Relays Tab.....	80	Web Server.....	14, 122
Remote Service.....	38, 56, 63, 69, 75, 79, 122	Write Multiple Coils.....	109, 145
Remote Service/SNMP.....	58, 69, 79	Write Multiple Registers.....	110, 147
Restoring Factory Default Settings.....	113	Write Single Coil.....	108, 143
Router.....	14, 26, 118	X	
S		XML Operation.....	95