



Web-Controlled Relay

User's Manual

Revision: 2.0 - January 23, 2006

**Covers: XRDI-WR1
XRDI-WR1-POE
XRDI-WR1-LS
XRDI-WR1-POE-LS**

CONTROL by
WEB
www.ControlByWeb.com

a division of...
Xytronix Research & Design, Inc.
North Logan, Utah, USA

Contents

Trademark and Copyright Information

Warranty

Installation Guidelines (Read Before Installing)

Section 1: Introduction

1.1 WebRelay Models Available

Section 2: Installation and Setup

2.1 Installation Options

2.1.1 Single WebRelay™ Device (IP Network Control Only)

2.1.2 Single WebRelay™ Device (Voltage and/or IP Network Control)

2.1.3 Single WebRelay™ Device (Monitor Only)

2.1.4 Dual WebRelay™ Devices (No Computer Required for Operation)

2.1.5 WebRelay™ Used for Reboot (Wired in series with Power)

2.1.6 WebRelay™ Used for Reboot (Wired to Reset)

2.1.7 WebRelay™ Used for Reboot (Wired in parallel with Power Switch)

2.2 Connection

2.2.1 Power Supply Connection

2.2.2 Network Connection

2.2.3 Relay Connection

2.2.4 Optically-Isolated Input Connection

2.3 Establishing Communications for Setup

2.3.1 Option 1: Assign a temporary IP address to WebRelay™

2.3.2 Option 2: Assign a temporary IP address to configuration computer

2.3.3 Open Configuration Web Page Setup

2.4 Web-Based Setup

2.4.1 Main Setup Page

2.4.2 Network Setup Page

2.4.3 Password Setup Page

2.4.4 Relay/Input Setup Page

2.4.5 Control Page Setup (When Relay Mode is set to Standard)

2.4.6 Control Page Setup (When Relay Mode is set to Automatic Reboot)

Section 3: Operation

3.1 Browser Operation (Standard Relay Mode)

3.2 Browser Operation (Automatic Reboot Relay Mode)

3.2 XML Operation

Appendix A: Restoring Factory Default Settings

Appendix B: Specifications

Appendix C: Open TCP Legal Notice

Trademark and Copyright Information

This document is Copyright ©2005-2006 by Xytronix Research & Design, Inc. All rights reserved. WebRelay™ and ControlByWeb™ are Trademarks of Xytronix Research & Design, Inc. 2005-2006.

Portions of the software used in WebRelay™ are open source and appropriate copyright and legal notices are listed at the end of this manual. All other parts of the software are property of Xytronix Research & Design, Inc. ©2005-2006. The hardware design, schematics, PCB layout, concept, graphics, users manual, etc., are property of Xytronix Research & Design, Inc. ©2005-2006. WebRelay™ may not be opened, dis-assembled, copied or reverse engineered.

No part of this manual may be reproduced or transmitted in any form or by any means, electronic or mechanical, including photocopying or scanning, for any purpose other than the personal use by the purchaser of this product. Xytronix Research & Design, Inc., assumes no responsibility for any errors that may appear in this document.

Whereas effort has been made to make the information in this document as useful and accurate as possible, Xytronix Research & Design, Inc. assumes no responsibility for the application, usefulness, or completeness of the information contained herein. Under no circumstance will Xytronix Research & Design, Inc. be responsible or liable for any damages or losses including direct, indirect, special, incidental, or consequential damages or losses arising from either the use of any information contained within this manual or the use of any products or services referenced in this manual.

Xytronix Research & Design, Inc. reserves the right to change any product's features, specifications, documentation, warranties, fee schedules, and conditions at any time and without notice.

Warranty

This Xytronix Research & Design, Inc. product has a warranty against defects in material and workmanship for a period of one year from the date of shipment. During the warranty period, Xytronix Research & Design, Inc. will, at its option, either repair or replace products that prove to be defective. This warranty is extended to the original purchaser of the equipment only.

For warranty service or repair, the product must be properly packaged, and returned to Xytronix Research & Design, Inc. The purchaser shall prepay all charges for shipping to Xytronix Research & Design, Inc., and Xytronix Research & Design, Inc. will pay the shipping charges to return the product to the purchaser as long as the product is shipped within the United States. If the product is shipped outside of the United States, the purchaser shall pay all shipping charges, duties, and taxes.

Limitation

The foregoing warranty shall not apply to defects or damage resulting from improper use or misuse, unauthorized repair, tampering, modification, improper connection, or operation outside the electrical/environmental specifications for the product. Further, the warranty does not cover Acts of God, such as fire, flood, hurricanes, and tornadoes. This warranty does not cover damage to property, equipment, direct, indirect, consequential, or incidental damage (including damage for loss of business profit, business interruption, loss of data, and the like) arising out of the use or misuse of this product. **UNDER NO CIRCUMSTANCES WILL THE LIABILITY OF XYTRONIX RESEARCH & DESIGN, INC. TO THE PURCHASER OR ANY OTHER PARTY EXCEED THE ORIGINAL PURCHASE PRICE OF THE PRODUCT, REGARDLESS OF THE FORM OF THE CLAIM.** No other warranty is expressed or implied. Xytronix Research & Design, Inc. specifically disclaims the implied warranties or merchantability and fitness for a particular purpose. Some jurisdictions may not allow the exclusion of limitation of liability for consequential or incidental damage.

Installation Guidelines (Read Before Installing)

- Do not open the WebRelay™ enclosure. This will void the warranty.
- This unit must be installed by qualified personnel.
- This unit must not be installed directly outdoors.
- This unit must not be used for medical, life saving purposes, or for any purpose where its failure could cause the loss of life.
- Proper security precautions should be made before installing WebRelay™ on the Internet.

Notes about security:

By design, WebRelay™ is very secure. It does not support terminal or file transfer programs such as telnet, ftp, ssh, etc. This means that it is not possible for someone to 'break in' to WebRelay™ and access other devices on your local network. WebRelay™ does not support remote firmware updates which means that it is not possible for someone to remotely install malicious software. The simplicity of WebRelay™ makes it a very secure device. As with any device to be installed on a network, there are some security precautions that should be observed. If WebRelay™ is installed on the Internet, it may be possible for someone to gain access to the WebRelay™ control web page and turn the relay on and off. For Internet installations, it is recommended that passwords be enabled for the control page. Make sure secure passwords are used. Passwords should be at least 8 characters in length and should be a combination of upper case letters, lower case letters, and numbers. Don't use passwords that would be easy to guess. For additional security, a firewall may be used to limit access only to selected IP addresses. Another option may be to set up a Virtual Private Network (VPN) between the network where WebRelay™ resides and the client machine (web browser, second WebRelay™, etc.).

Section 1: Introduction

WebRelay™ is an electro-mechanical relay with a built in web server. It can be controlled and/or monitored over any IP network including private networks, IP-based industrial control networks, and the Internet. Users can operate WebRelay™ using a web browser or a custom application. Computers or automation controllers may control and monitor WebRelay™ without user intervention. This works by sending text commands over the network and reading XML status pages from WebRelay™. WebRelay™ can also be operated by using the optically isolated input. The optically isolated input can be configured to turn the relay on/off, pulse the relay, toggle the relay, latch the relay (for alarming), etc. The input can also be used to control a relay at a remote location or to simply monitor the status of a digital signal.

WebRelay™ has many applications and is only limited by imagination. It works very well as a stand-alone device that can be controlled using a web browser or as a convenient way to add I/O to a computer. It can be used in industrial applications to control motors, lights, coils, pumps, valves, etc. It can also be used to monitor switches, sensors, and control voltages.

In addition, WebRelay™ is designed to function as a high-end reboot controller and offers many reboot options. It can be used to remotely reboot servers, computers, satellite modems, or other devices over the Internet, or it can be configured to automatically reboot devices when they fail to respond to pings that are sent from WebRelay™. There are three ways that WebRelay™ can be wired to a device for reboot. First, WebRelay™ can be wired in series with the power source of the device and simply switch the power on and off. Second, WebRelay™ can be wired in parallel with the power switch of the device. This is useful for devices that will not automatically start operating when power is applied. These devices require a user to press a power switch before the device will boot. The third option is to connect WebRelay™ to the reset input of a device. In this configuration, WebRelay™ does not power down the device, but simply causes the device to reset. All three reboot methods have different requirements in physical connection and relay timing. WebRelay™ fully supports all three.

1.1 WebRelay Models Available

WebRelay™ is currently available in four models. All four models function identically but have hardware differences. The four models are described below.

XRDI-WR1 has 10 Amp relay contacts and operates from a 5VDC power supply.

XRDI-WR1-LS has 1 Amp relay contacts and operates from a 5VDC power supply.

XRDI-WR1-POE has 10 Amp contacts and can optionally be powered over an Ethernet line (802.3af).

XRDI-WR1-POE-LS has 1 Amp relay contacts and can optionally be powered over an Ethernet line (802.3af).

The models that can be powered over the Ethernet line (-POE) are very useful for installations where a 5VDC power source is inconvenient or difficult to obtain. These models may be powered over the ethernet line or a 5V power supply may be used.

The models with 10 Amp contacts are convenient for direct control of devices that operate at line voltages.

The low signal models (-LS) with 1 Amp contacts are recommended for low power applications. The contacts in the LS models are designed to maintain a low resistance and reliably conduct low signals for the life of the relay.

Section 2: Installation and Setup

Installation consists of connecting WebRelay™ to an IP network, providing power, configuring via a web browser, and wiring relay contacts to the device that will be controlled. Optionally, a control signal may be connected to the optical input.

2.1 Installation Options

WebRelay™ is very versatile and can be used in many applications. Several basic installation schemes are illustrated in this section.

2.1.1 Single WebRelay™ Device (IP Network Control Only)

This configuration is used for remote control of a device using a web browser or a control script/application running on a computer.

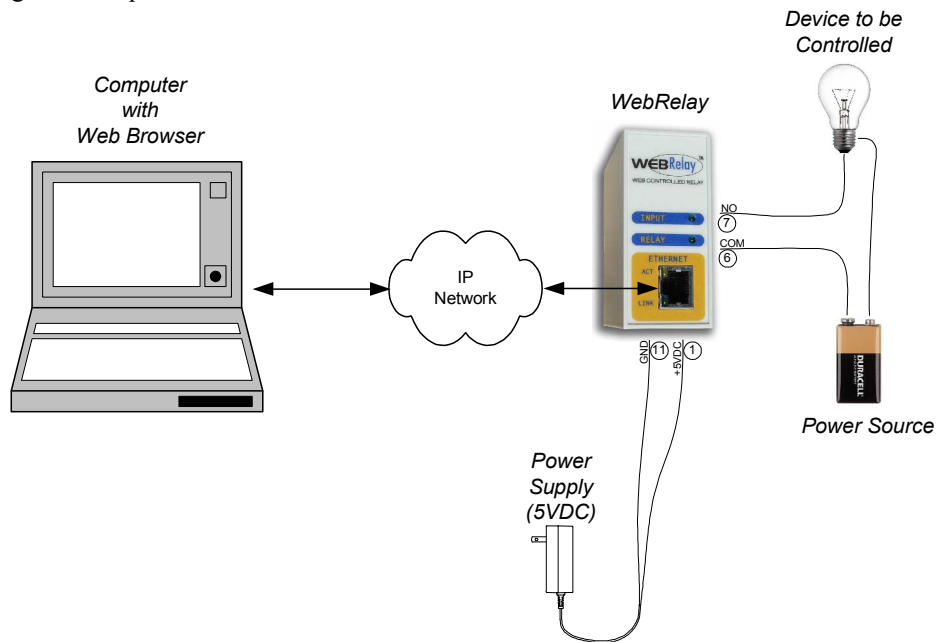

2.1.2 Single WebRelay™ Device (Voltage and/or IP Network Control)

This configuration allows devices to be controlled using a web browser, an application running on a computer, or a control voltage. The control voltage input could be connected directly to the output of a PLC; or a mechanical switch or sensor can be used by “borrowing” the voltage from the power supply (as shown in the following illustration). Note that this scheme of “borrowing” the voltage for control purposes also works on WebRelay™ units with the power-over-ethernet option because the power-over-ethernet units provide 5V on the power pins.

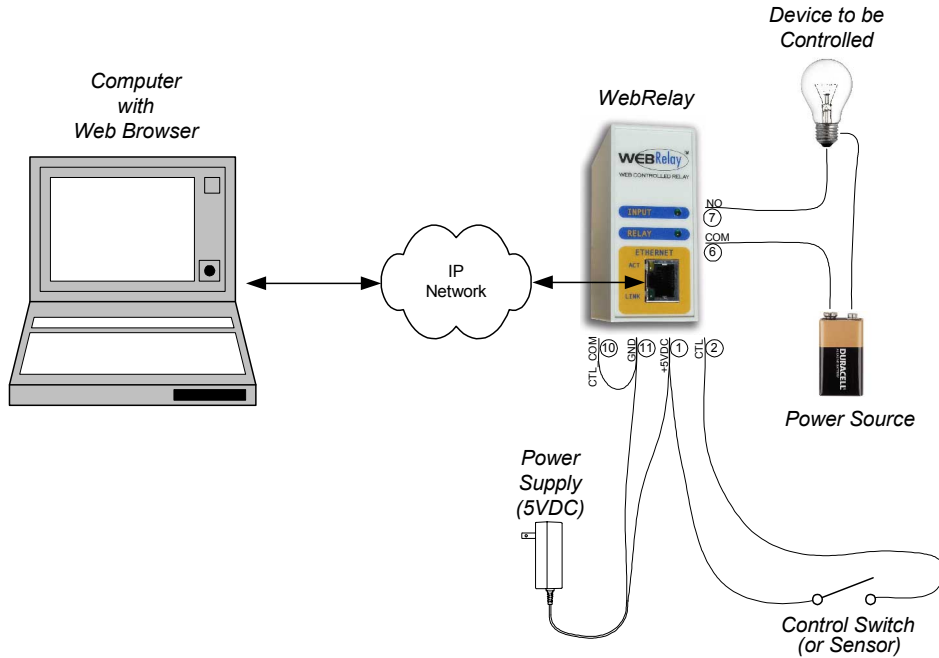

2.1.3 Single WebRelay™ Device (Monitor Only)

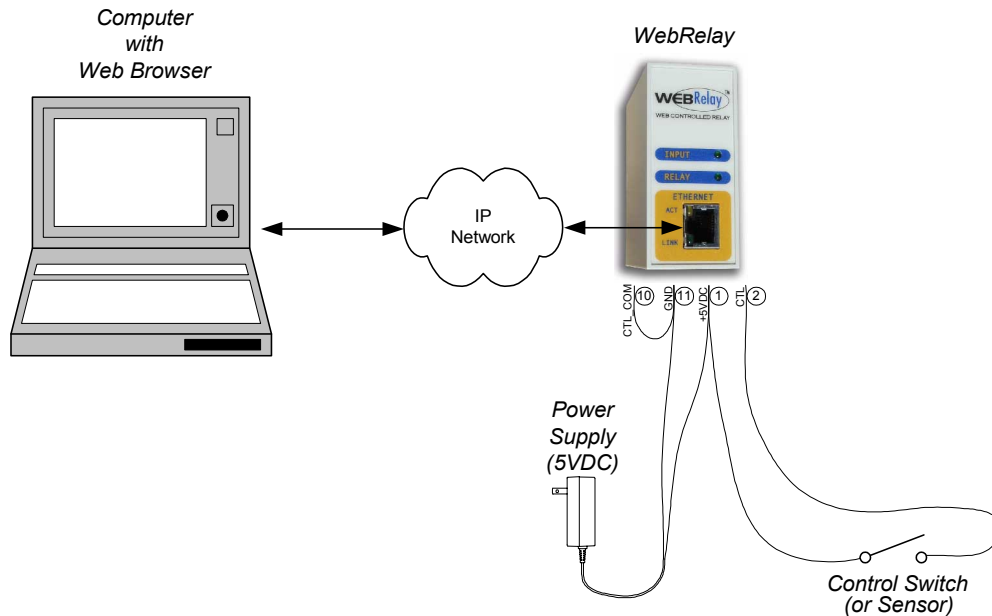

WebRelay™ can be used to monitor the status of a device without necessarily controlling anything. Status can be viewed using a web browser or monitored by requesting the XML page. In this example, the internal relay is not being used.

2.1.4 Dual WebRelay™ Devices (No Computer Required for Operation)

This configuration is used to control devices remotely without a browser, or to extend a digital signal to a remote location on the network. A control voltage applied to one unit controls the relay contacts of another unit at a remote location.

An example of this configuration might be to extend the output of a PLC (Programmable Logic Controller) in a factory to control a motor in another building. The output of the PLC is connected to the control voltage input of one WebRelay™ device and the motor would be connected to the relay contacts of a second WebRelay™ device.

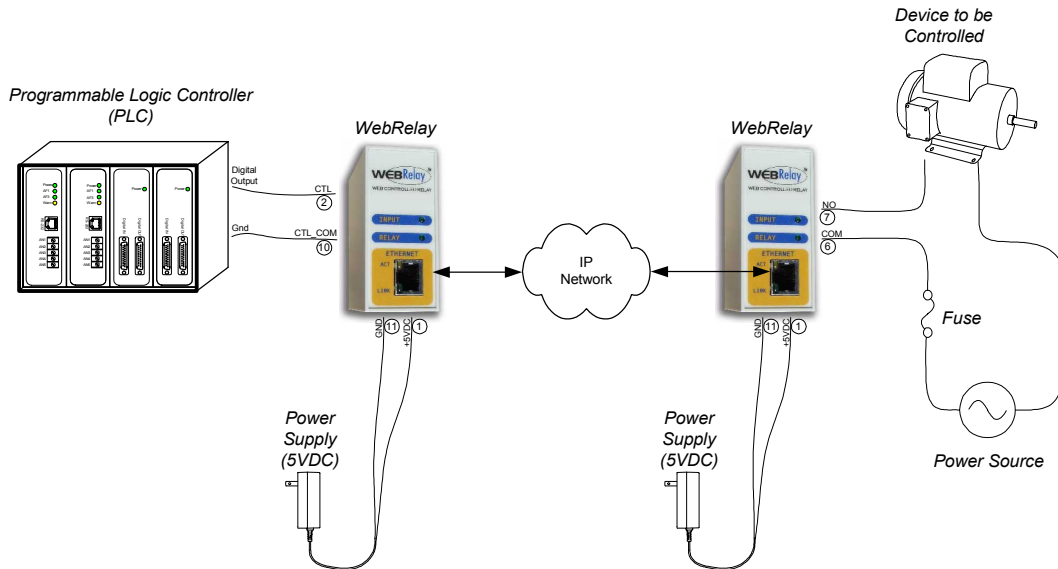

Another example might be to connect an alarm contact in a vacation home to the input of a WebRelay™ unit. A second WebRelay™ device at another location could control a buzzer or chime. This would immediately announce entry to the vacation home at a distant location.

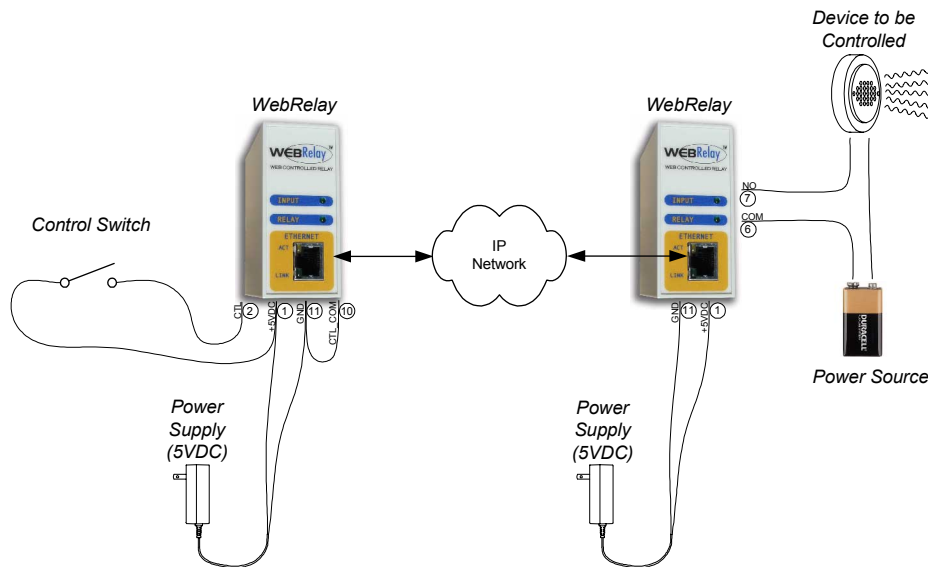

2.1.5 WebRelay™ Used for Reboot (Wired in series with Power)

The illustration below shows one example of how WebRelay™ can be used to reboot a server. WebRelay™ is wired in series with the servers power source which allows it to turn the server on and off. Note that the server shown is powered by a transformer, but WebRelay™ is rated up to 10Amps (non LS model) so servers that operate on line voltages can also be used as long as proper wiring techniques are used for safety.

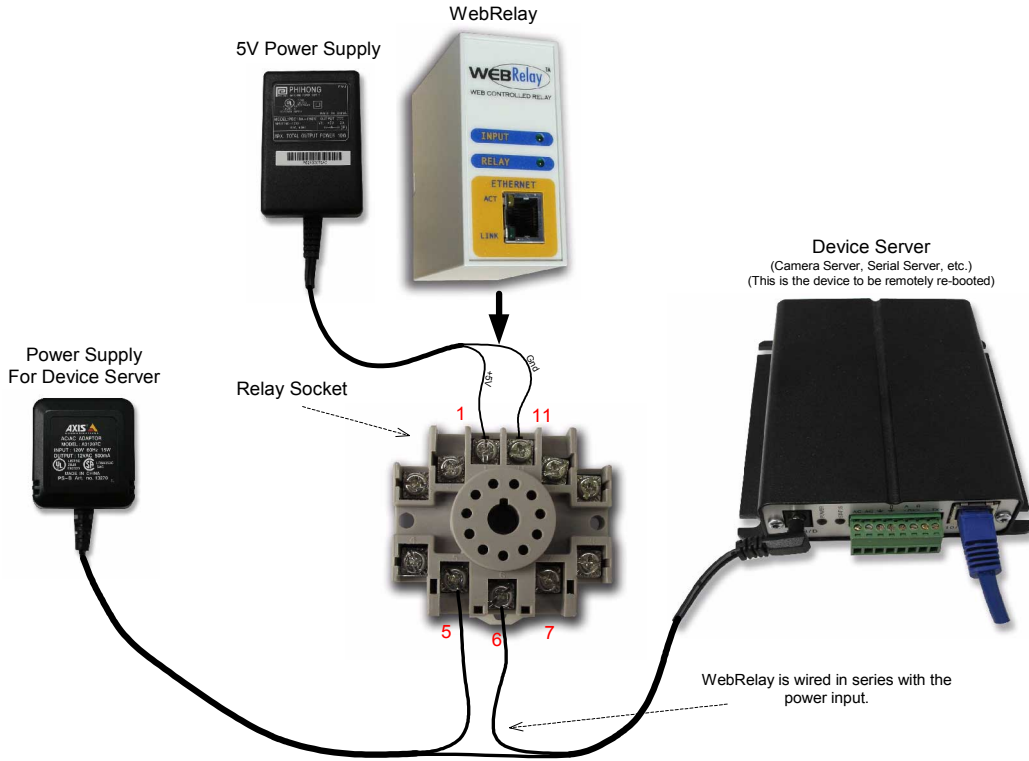

2.1.6 WebRelay™ Used for Reboot (Wired to Reset)

The illustration below shows how WebRelay™ can be wired to the reset circuit of a computer motherboard. In this scenario, the computer is never powered down, only reset when necessary by temporarily closing the relay contacts. This approach is more gentle on the computer than the approach of switching the power. WebRelay™ is wired to the reset circuit by disconnecting the small cable that connects the reset button to the motherboard and replacing it with a cable that connects to the contacts of WebRelay™. The pushbutton may be connected in parallel with the WebRelay™ contacts or may not be used.

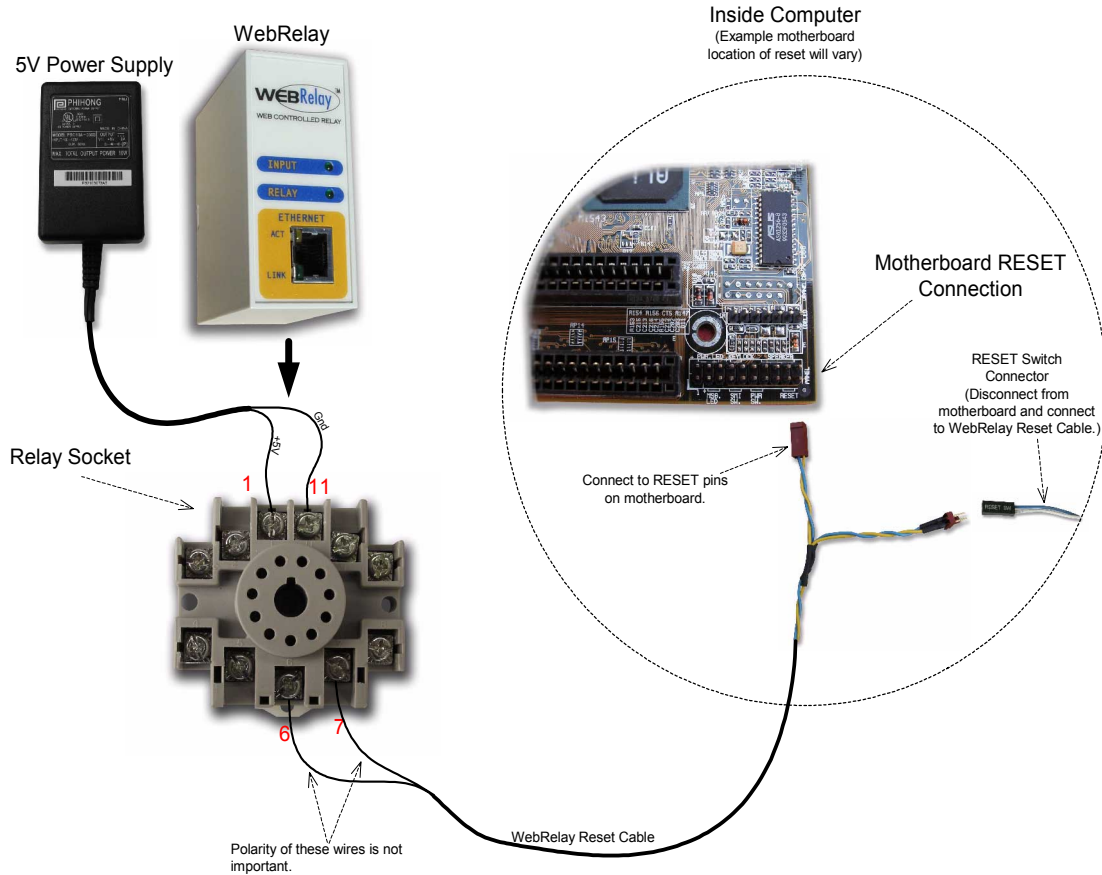

2.1.7 WebRelay™ Used for Reboot (Wired in parallel with Power Switch)

Many computers have momentary power buttons that are wired to the motherboard similar to the way the reset button is wired. The previous example that describes connecting WebRelay™ to the reset circuit can be used to illustrate connection. Instead of connecting WebRelay™ contacts to the motherboard reset, connect the contacts to the power control pins on the motherboard.

2.2 Connection

Power, relay contacts, and control voltage connections to WebRelay™ are made through the 11-pin connector on the bottom of the unit. This connector plugs into an industry standard 11-pin octal relay socket. Xytronix Research & Design, Inc. has sockets available that may be DIN-rail mounted or wall mounted. The network (and power on POE units) is connected through the RJ-45 connector on the front of the unit.

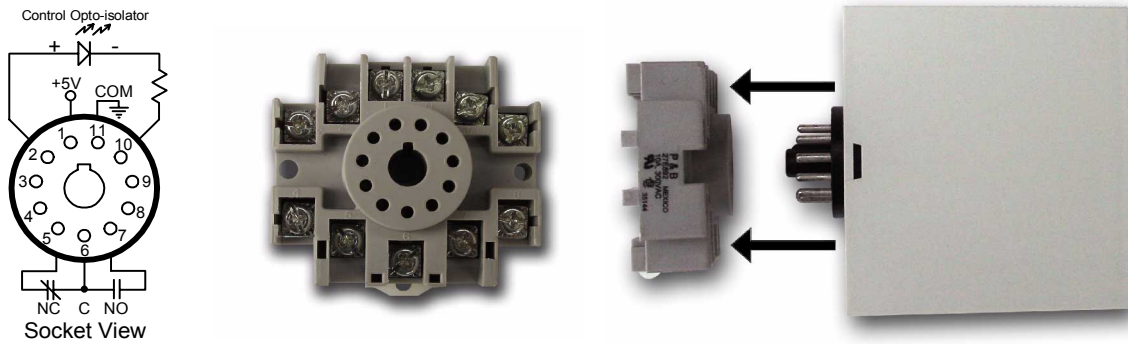

11-pin connector pinout:

Pin	Description
1	+5VDC power supply input. Connect to the positive side of a regulated 5VDC power supply. The power supply must be able to deliver at least 500mA. WebRelay™ units that have the power-over-ethernet option (-POE) do not require a power supply to be connected to this pin. Note that when WebRelay™ is powered over the ethernet network, this pin becomes a +5VDC power output. This can be used as a source for a control voltage. Do not use this pin to supply more than 100mA to an external device.
2	Optically-isolated input (+). When an input signal is connected, the positive side of the input signal must be connected to this pin. An internal resistor is provided. The input range is 5-12VDC.
3	No connection
4	No connection
5	Normally closed relay contact
6	Common relay contact
7	Normally open relay contact
8	No connection
9	No connection
10	Optically-isolated input (-). When an input signal is connected, the negative side of the input signal must be connected to this pin. An internal resistor is provided. The input range is 5-12VDC.
11	Power supply common (ground)

2.2.1 Power Supply Connection

The WebRelay™ unit requires power for its internal logic circuits. A 5VDC power supply must be connected to WebRelay™ through the relay socket connector. Alternatively, WebRelay™ units with the Power Over Ethernet option may be powered through the Ethernet connection instead of using an external power supply.

Multiple WebRelay™ units may be connected to a single power supply by connecting their power supply inputs to a power supply in parallel. The power supply must be rated for at least 500mA for each WebRelay™ connected.

WebRelay™ units with the Power Over Ethernet option may be connected to an 802.3af compliant Ethernet port instead of connecting a 5V power supply. This eliminates the need for a 5VDC power supply because WebRelay™ is powered through the Ethernet port. The power in the Ethernet port comes from an 802.3af compliant hub, switch, or power injector which may be located in a utility closet which could be a distance away from WebRelay™. This option is very useful for WebRelay™ installations where power is not available for a 5V power supply.

2.2.2 Network Connection

Connect the Ethernet port to a 10 Base T or 10/100 Base T Ethernet connection. This typically connects to an Ethernet hub, switch, or router. For configuration, WebRelay™ may be connected directly to the Ethernet port on a computer using a “crossover” cable. Otherwise for connection through a hub or router, a standard “straight-thru” cable should be used.

2.2.3 Relay Connection

The relay contacts internally connect directly to the socket. No internal fuse is provided. The relay contacts are rated at 1 Amp or 10 Amps depending upon the model. If the power source connected to the relay contacts can deliver more than 10 Amps, an external fuse or circuit breaker must be used. Direct access to Common, Normally Open, and Normally Closed contacts are provided. The relay contacts may be wired in series with the power source for a device that will be controlled as shown in the figure below.

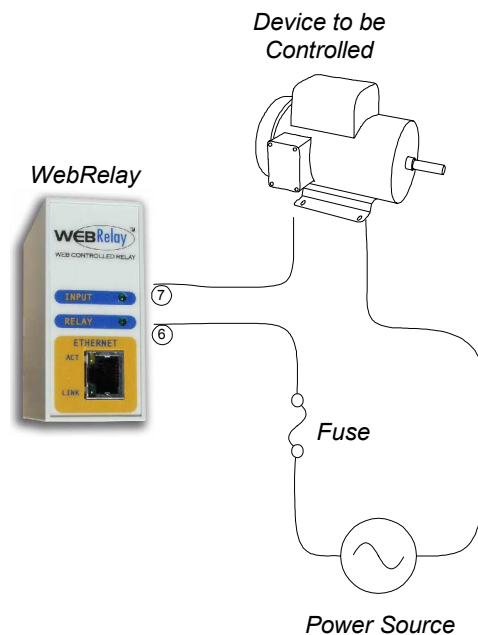

Many of the illustrations in this manual show WebRelay™ contacts wired in series with a power source which allows the power for the device to be switched on and off remotely. In many cases, however, it is useful to control other functions and not just power. One way to do this is to connect relay contacts in parallel with pushbutton switches within a device. An example is useful to illustrate this. Suppose you have a gate controller system that has a pushbutton switch that opens a gate when pressed. The button that controls the gate is located on one side of the building, but you want to be able to open the gate from a room on the other side of the building. Since the building is pre-wired for networking, it is a simple task to connect a WebRelay™ unit in parallel with the pushbutton. An illustration of this is shown below. In doing this, you can now operate the gate with the existing pushbutton, or you can operate the gate from another room using a web browser. Another option (not shown here), would be to connect another pushbutton switch to a second WebRelay™ device in a room across the building. The second device could be configured to send control messages to the first device each time the new pushbutton is pressed. As a result, you would have a second pushbutton that could operate the gate.

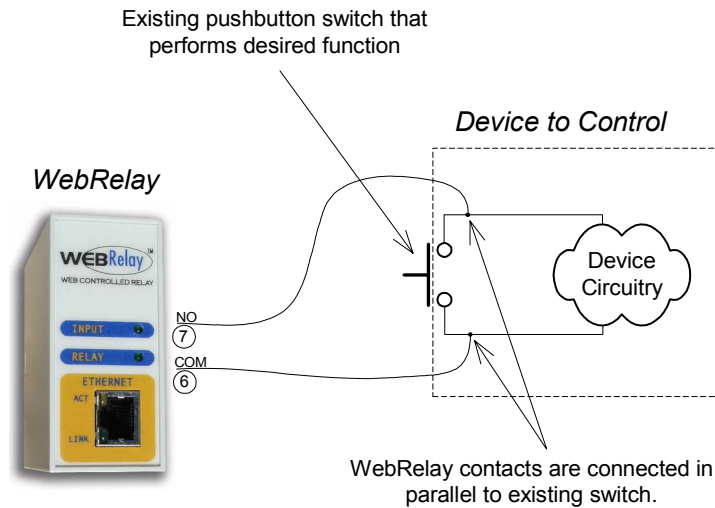

WARNING: Connecting WebRelay™ to a device as shown in the illustration above may void the warranty of the device. Additionally, many electrical devices contain dangerously high voltages (even with power disconnected) and should not be opened. The connection illustrated should only be performed by very qualified personnel. Xytronix Research & Design, Inc. will not be responsible or liable for any injury or damage caused by using this connection scheme.

2.2.4 Optically-Isolated Input Connection

The optically-isolated input can be used to control the relay, control a remote relay, or simply to monitor a discrete device. To use this input, connect a voltage (5-12 Volts DC) directly to the control input. A current limiting resistor is provided internally, so no external resistor is required.

2.3 Establishing Communications for Setup

WebRelay™ is set up using a web browser. The first task is to establish communications between a computer and the WebRelay™ device so that the browser-based configuration can begin. To do this, the computer and WebRelay™ must be physically connected to the same network and both must have IP addresses on the same network. There are two ways to set up the computer and WebRelay™ so that they are on the same network. The first way (Option 1) is to change the IP address of WebRelay™ to an address that is on the same network as the computer. The second way (Option 2) is to change the IP address of the computer to an address that is on the same network that WebRelay™ is set to by default.

2.3.1 Option 1: Assign a temporary IP address to WebRelay™

This option is used to TEMPORARILY assign an IP address to WebRelay™ without the need to change the IP address of the configuration computer. It is the recommended method for establishing initial communications. Note that WebRelay™ will only use this IP address as long as power is maintained. Once power is lost and restored, WebRelay™ will use the IP address assigned in the setup page and not the temporary address assigned here. This means that once communications are established, the desired IP address should be entered into the network setup page using the browser.

To assign the temporary IP address...

1. Make sure WebRelay™ and the configuration computer are connected to the same physical network. This will not work through routers or gateways.
2. Assign the address as follows...

Windows:

Open a Command Prompt (on Windows XP, select START, then RUN, then type “cmd”).

Type...

```
arp -s {new IP address} {serial number of WebRelay™ }
```

Note: IP address format is: xxx.xxx.xxx.xxx
Serial number format is: ss-ss-ss-ss-ss-ss

For example, to set a WebRelay™ device (with serial number 00-0C-C8-01-00-01) to 10.10.10.40 the following command would be used.

```
arp -s 10.10.10.40 00-0c-c8-01-00-01
```

Next, type...

```
ping -l 102 {new IP address}
```

For example, if the new IP address is 10.10.10.40, the following command would be used.

```
ping -l 102 10.10.10.40
```

Linux/Unix:

Open a terminal, change to root user (su -, then enter root password).

Type...

```
arp -s {new IP address} {serial number of WebRelay™ }
```

Note: IP address format is: xxx.xxx.xxx.xxx
Serial number format is: ss:ss:ss:ss:ss:ss

For example, to set a WebRelay™ device (with serial number 00-0C-C8-01-00-01) to 10.10.10.40 the following command would be used.

```
arp -s 10.10.10.40 00:0c:c8:01:00:01
```

Next, type...

```
ping -s 102 {new IP address}
```

For example, if the new IP address is 10.10.10.40, the following command would be used.

```
ping -s 102 10.10.10.40
```

Mac OS X

Open a terminal,

Note that the terminal is in the “Utilities” directory which is in “Applications” directory.

```
type
```

```
sudo arp -s {new IP address} {serial number of WebRelay™ }
```

Note: Administrator password is required.
IP address format is: xxx.xxx.xxx.xxx
Serial number format is: ss:ss:ss:ss:ss

For example, to set a WebRelay™ device (with serial number 00-0C-C8-01-00-01) to 10.10.10.40 the following command would be used.

```
sudo arp -s 10.10.10.40 00:0c:c8:01:00:01
```

Next, type...

```
ping -s 102 {new IP address}
```

For example, if the new IP address is 10.10.10.40, the following command would be used.

```
ping -s 102 10.10.10.40
```

2.3.2 Option 2: Assign a temporary IP address to configuration computer

If the first option above is not used, you can use this option to communicate with WebRelay™ . By default, WebRelay™ comes from the factory with an IP address of 192.168.1.2. Communications with WebRelay™ may be established by assigning an IP address to the configuration computer that is on the same network as WebRelay™ (for example the configuration computer could be assigned to 192.168.1.5) .

Instructions for changing the IP address of the computer that will be used for WebRelay™ configuration are given here. Note that these instructions are specifically for computers with the Windows XP operating system. For setup using other operating systems, refer to the appropriate users manual.

Step 1: Open the control panel by clicking on the start menu and then clicking on Control Panel. (Note that control panel shown is in “Classic View”. If control panel is in “Category View” select the “Classic View” option before proceeding.)

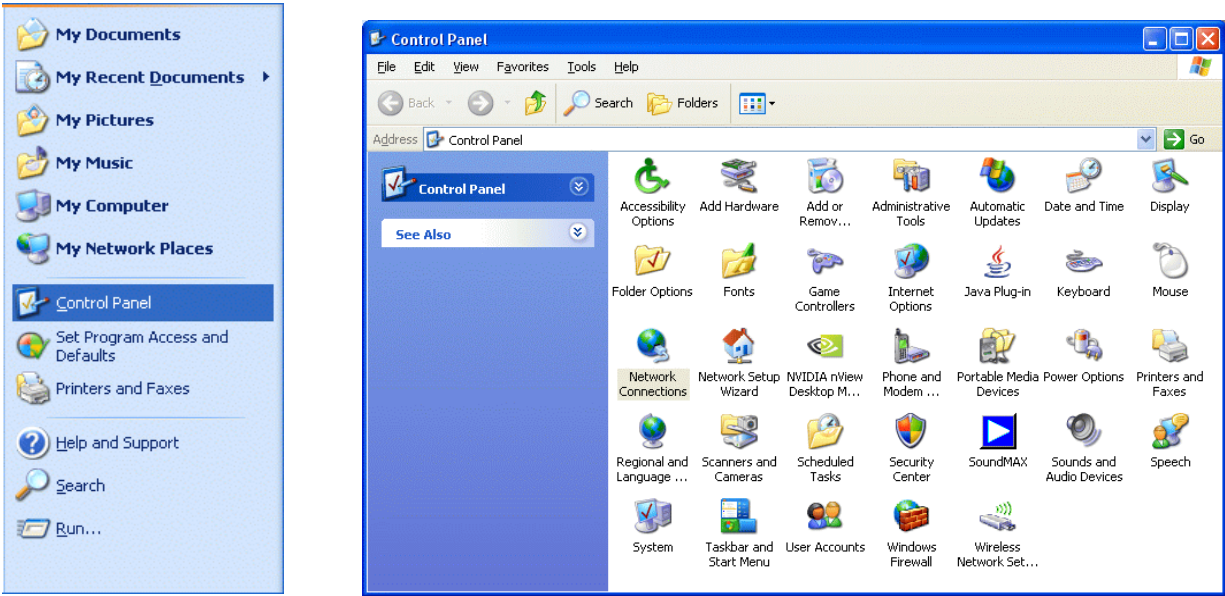

Step 2: Double click on the icon labeled Network Connections. The following menu will pop up.



Step 3: Right click on the icon labeled Local Area Connection. Another menu will appear. Select the option at the bottom of the menu labeled Properties. The Local Area Connection Properties window will appear.

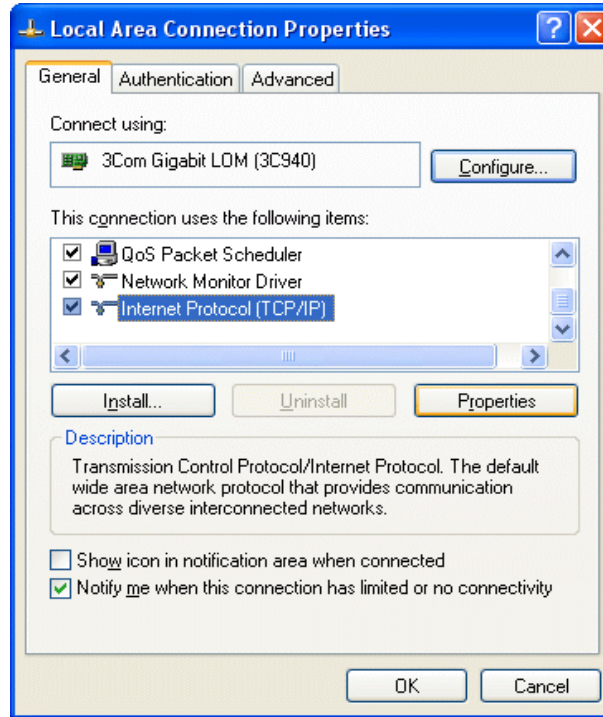

Step 4: On the Local Area Connection Properties page scroll down to Internet Protocol (TCP/IP), select it, and then click the button labeled properties.

Step 5: Before making any changes to the network settings, write down the current settings so that they can be restored once WebRelay™ is configured. Next, select the radio button labeled “Use the following IP address,” and type in the IP address 192.168.1.50. Type in a subnet mask of 255.255.255.0. Leave the default gateway field blank.

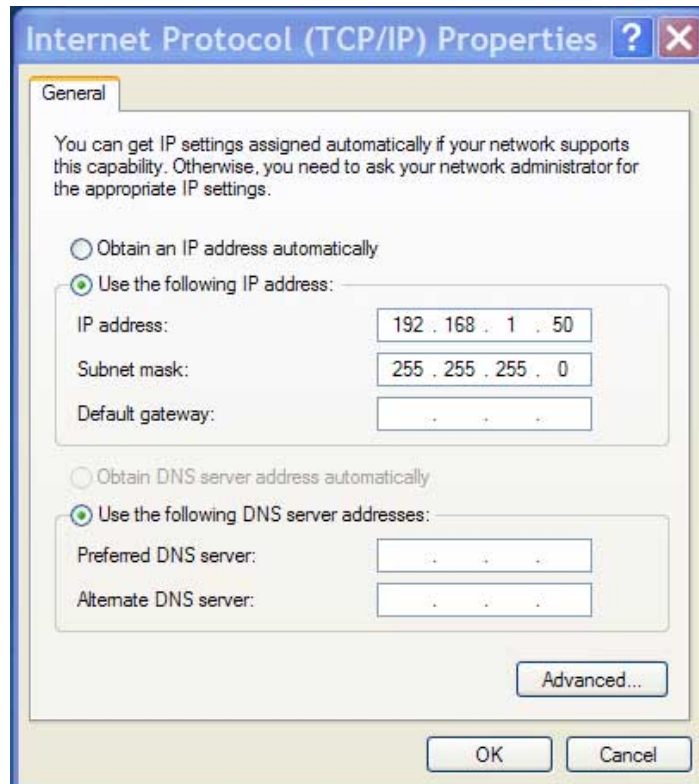

2.3.3 Open Configuration Web Page

Once the network is set up, open the configuration setup page by typing the following URL into the browser: <http://192.168.1.2/setup.html> (note that if option 1 above was used for initial configuration, replace the IP address given here with the newly assigned IP address). A password is required to change any parameters. The default password is 'webrelay' (do not include quotes, password is case sensitive).

2.4 Web-Based Setup

WebRelay™ is fully configurable through HTML 4.0 compliant web browsers such as Internet Explorer and Mozilla Firefox. It's easy to use tab based menu system has been designed to allow the unit to be configured easily. Note that in this chapter, the default IP address of 192.168.1.2 is used in all examples. If the IP address has been changed, substitute the new IP address for the address shown in the examples.

Before proceeding, make sure a network connection has been established between the computer and WebRelay™. This is done by typing the following URL into the web browser: `http://192.168.1.2/setup.html`. Another way to check communications is to ping WebRelay™ (from the command prompt (type `ping 192.168.1.2`)). Each setup page is described below.

2.4.1 Main Setup Page

This is the initial page that appears when the URL `http://192.168.1.2/setup.html` is entered into the web browser. It provides basic information about the WebRelay™ unit.

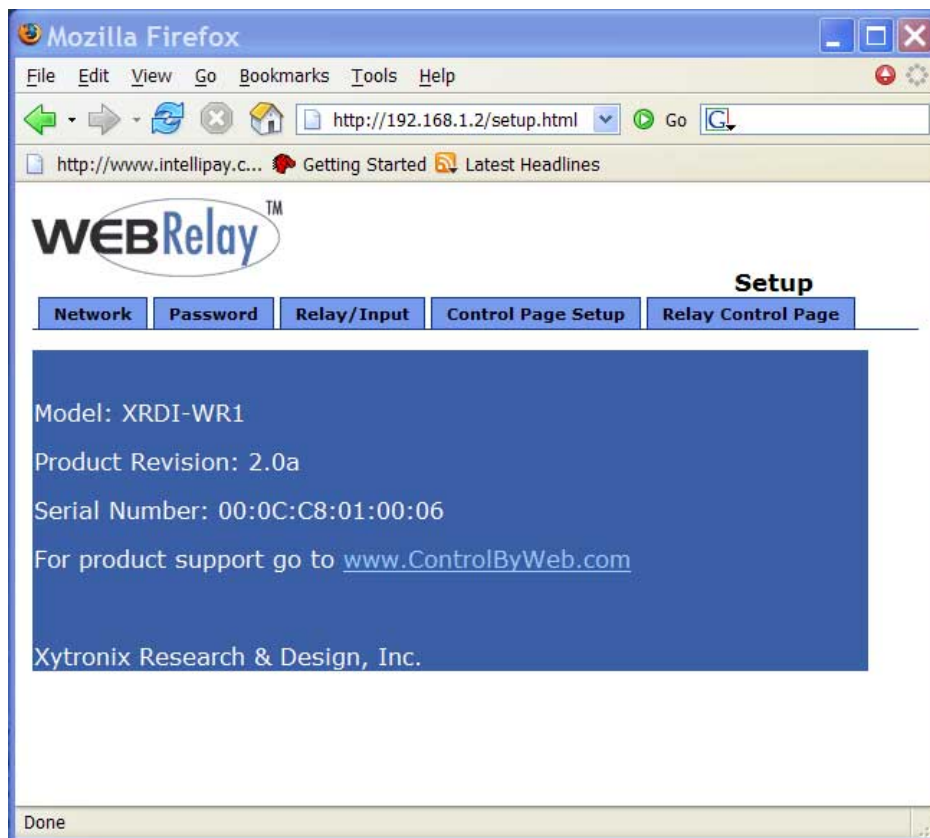

Navigating between setup pages is done by clicking on the tabs at the top of the page. All setup pages require a password. The default password is 'webrelay' (no quotes, all lower case) and no username is required. Once the password is entered, it will not be required again unless the password is changed or the browser is closed.



Each setup page has a “Submit” button and a “Reset” button at the bottom of the page. After entering the desired parameters into each page, the “Submit” button must be pressed before any parameters will be saved. If a mistake is made in entering the parameters, the “Reset” button may be used to restore all parameters on the page to their current settings. The “Reset” button is only effective before the “Submit” button is pressed.

2.4.2 Network Setup Page

The network parameters are changed on this page. Note that if multiple WebRelay™ units are used on the same network, install one unit at a time and set the IP address of each unit before connecting the next unit to the network. This avoids having multiple WebRelay™ units installed on the network with the same factory default IP address at the same time. Also note that the unit must be power-cycled (power disconnected, then reconnected) before network settings take effect. No other setup page requires power-cycling for the settings take effect.

1. IP Address:

WebRelay™ requires a static IP address. This is a unique address that identifies WebRelay™ on the network. Dynamic IP address assignment is not supported. The lack of dynamic IP addressing support is intentional because a dynamically changing the IP address would make it difficult for a client to access the web server built into WebRelay™. The IP address is specific to the network where WebRelay™ will be installed, and must be obtained from the network administrator.

This guide is not meant to be a tutorial on IP addressing, however a few comments about IP addressing are given here.

If WebRelay™ will be used over the Internet, the IP address must be a routable address assigned by the upstream Internet Service Provider (ISP).

In cases where the ISP only provides a single routable IP address for the entire network (this is typical with ISPs such as cable providers), a proxy server (or gateway router) may be used. A proxy server allows multiple devices to connect to the Internet using a single routable IP address. Many small routers from LinkSys, Dlink, and Netgear perform proxy server functions. If a proxy server is used, WebRelay™ will not be accessible from the Internet until the proxy server is properly

configured (forward proper port to WebRelay™). This information is mentioned for convenience but details of setting up a configuration such as this is beyond the scope of this manual.

If WebRelay™ is used on a private network only and is NOT used over the Internet, a routable IP address is not necessary. This may be the case when WebRelay™ is used to control (or monitor) a device in another room or a nearby building.

If WebRelay™ will be installed on a simple, private network that does not connect to the Internet, the default IP address may be used as long as no other device on the network uses the same address. If multiple WebRelay™ units are installed on the same network, each unit must have its own unique IP address. For example, WebRelay™ comes from the factory with a default IP address of 192.168.1.2. If multiple units are used, change the IP address for each unit (192.168.1.3, 192.168.1.4, 192.168.1.5 etc.).

2. Netmask:

This specifies the size of the local network. This must be obtained from the network administrator. By default, the netmask is set to 255.255.255.0.

The screenshot shows the WebRelay™ Setup interface. The browser window title is "http://192.168.1.2/setup.html - Microsoft Internet Explorer". The address bar contains "http://192.168.1.2/setup.html". The page has a blue header with the WebRelay™ logo and the word "Setup". Below the logo are five tabs: "Network", "Password", "Relay/Input", "Control Page Setup", and "Relay Control Page". The "Network" tab is active, displaying a form with the following fields:

IP Address:	192	168	1	2
Netmask:	255	255	255	0
Broadcast:	192	168	1	255
Gateway:	192	168	1	1
TCP Port:	80			

Below the form are "Submit" and "Reset" buttons. A message above the form states: "Network parameters require reboot before they take effect."

3. Broadcast:

This specifies the broadcast address. This must be obtained from the network administrator. By default, this is set to 192.168.1.255.

4. Gateway:

This specifies the IP address of the gateway router. This must be obtained from the network administrator. By default, this is set to 192.168.1.1. If no gateway is used, this can be set to 0.0.0.0 which will prevent WebRelay™ from looking for a gateway.

5. TCP Port:

This specifies the TCP port used for communications with WebRelay™. By default, the port is set to 80 which is the standard http port. It is recommended that the port not be changed without an understanding of TCP/IP and ports.

Changing the port can be useful for accessing multiple WebRelay™ devices which are installed behind a gateway router on a private network that uses non-routable IP addresses (192.168.x.x, 10.x.x.x, and 172.16.x.x through 172.31.x.x are non-routable or private IP addresses). In this case, each WebRelay™ unit would be assigned a different port (for example 8000, 8001, 8002, etc). The gateway router would be set up to forward all traffic for each of the assigned ports to the IP address of the WebRelay™ unit which uses that port. The WebRelay™ units could then be accessed from outside the private network by entering the IP address of the gateway and the port for the desired WebRelay™ unit. Note that whenever any port is assigned other than port 80, all communications with that WebRelay™ device must include the port. For example, if WebRelay™ is assigned port 8000, access to the setup page would require the following URL to be entered; <http://192.168.1.2:8000/setup.html>.

An example screenshot of a gateway router configuration is given below. This setup allows five WebRelay™ units to be accessed on a private network behind a gateway. Note that this screenshot is simply an example of a typical router setup page. Routers will vary.

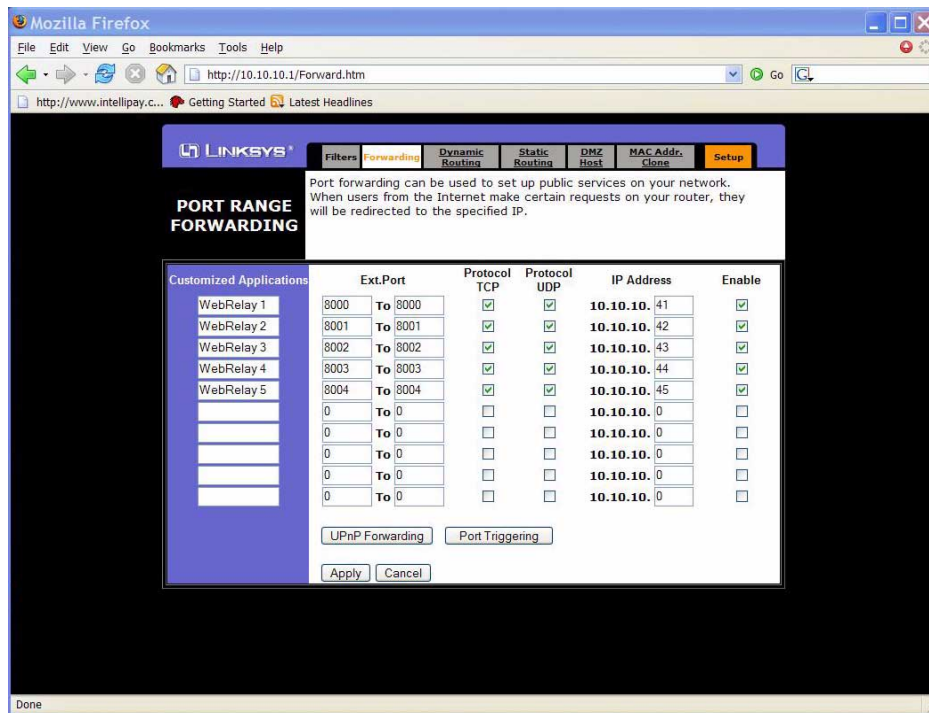

In the example, the five WebRelay™ devices are assigned IP addresses of 10.10.10.41 to 10.10.10.45. The WebRelay™ device with IP address 10.10.10.41 is assigned port 8000. The second WebRelay™ device with IP address of 10.10.10.42 is assigned port 8001. This pattern continues through 10.10.10.45 which is assigned the port 8004. To access the WebRelay™ units from the Internet, enter the IP address of the gateway plus the port number of the desired WebRelay™ unit.

2.4.3 Password Setup Page

The password setup page is used to change and enable passwords. A password is required for the setup pages but is optional for the control page. The password is enabled or disabled for the control page by using

the **Yes** or **No** radio buttons. Enabling the control page password also enables the requirement for a password when reading/writing XML pages. Note that when the password is changed, the password may be displayed in the browser's history in clear text. It is advisable to clear the browser's history after setting the password.

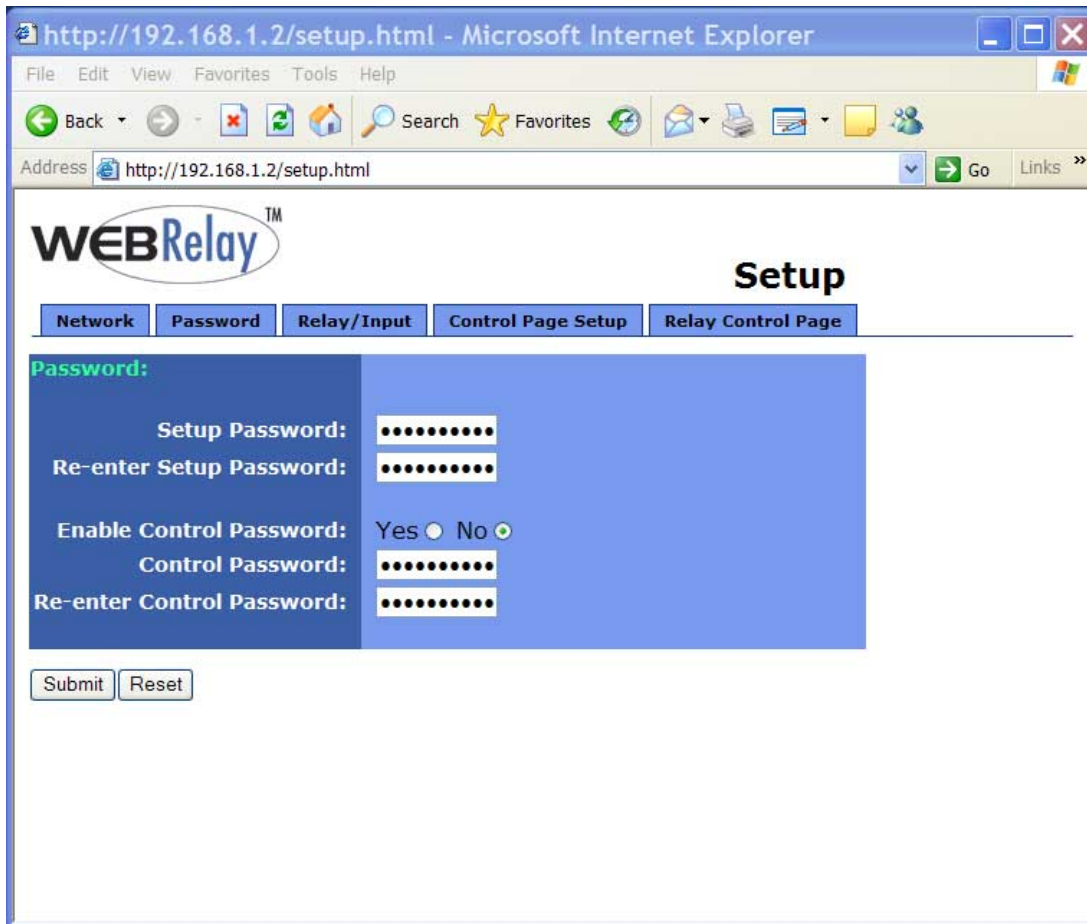

2.4.4 Relay/Input Setup Page

This page is used to set up the function of the relay and the control input. Note that in this manual, the relay is considered to be *on* when the relay coil is energized. When the relay coil is *on*, the normally open contacts are closed and the normally closed contacts are open. When the relay coil is *off*, the coil is not energized and the normally closed contacts are closed and the normally open contacts are open. Also note that in this manual the input is considered to be *on* when a voltage is applied to the input. The LEDs on the front panel of WebRelay™ will illuminate whenever the relay or input are in the *on* state.

1. Relay Mode:

The unit may be configured so that it operates in **Standard** mode or **Automatic Reboot** mode.

Standard mode is used for all applications except automatic reboot applications. Unless WebRelay™ will be used as an automatic reboot controller, **standard** mode should be selected. In cases where WebRelay™ will be used to remotely reboot devices but not for automatic reboot, **standard** mode should still be selected.

Automatic Reboot mode is used to configure WebRelay™ as a reboot controller. When this option is selected, the options in both the Relay/Input and the Control Page Setup menus change. In **Automatic Reboot** mode, WebRelay™ is configured to periodically confirm that another device

(such as a server, computer, router, etc.) is working by sending ping requests to the device. WebRelay™ expects a response after each ping. If a pre-set number of ping requests fail, it is assumed that the device is not functioning properly. WebRelay™ will attempt to restore the device to normal operation by rebooting the device. In **Automatic Reboot** mode, users also have the ability to manually reboot the device from a remote location over the network. Note that when WebRelay™ is set to **Automatic Reboot** mode, at power-up it will automatically turn the device on. This is so that users will not need to manually turn the device on when the power fails. Also note that from the control page, users can temporarily disable the automatic reboot function but it will automatically be re-enabled if WebRelay™ loses and regains power. Finally, note that the optically-isolated input cannot be used to control the local relay in this mode. In this mode the status of the input may be displayed on the control page or the input may be used to control a WebRelay™ at a remote location but local relay control is disabled.

The screenshot shows a Mozilla Firefox browser window displaying the WebRelay™ Setup page. The address bar shows the URL `http://192.168.1.5/setup.html`. The page features a navigation menu with tabs for Network, Password, Relay/Input, Control Page Setup, and Relay Control Page. The 'Relay/Input' tab is active, showing the following configuration options:

- Relay Mode: Standard Automatic Reboot
- Pulse Duration: 1.5 secs
- Relay Options: set relay equal input (init at powerup)
- Remote Relay Options: no remote relay control
- Remote Relay IP Address: 192 . 168 . 1 . 3
- Remote TCP Port: 80
- Relay #: 0
- Password: *****
- Keep Alive: YES(No TX State)

At the bottom of the configuration area, there are 'Submit' and 'Reset' buttons. The browser's status bar at the bottom indicates 'Done'.

The following parameters (2-3) are available when WebRelay™ is set to **Standard** relay mode.

2. Pulse Duration:

When WebRelay™ receives a command (from over the network or through an input change) to *pulse* the relay, this is the time in seconds that the relay will pulse *on*. This time can be set from 0.1 seconds to 6000 seconds (100 minutes). The factory default setting for this is 1.5 seconds.

3. Relay Options:

The optically-isolated input can be configured to control the relay. The 'Relay Options' setting is used to specify if and how the input affects the local relay. The options in the drop down list are described below. Note that in all cases, input changes will only affect the relay at the time the input is changed. Once the change has taken place the state of the input has no effect on the state of the relay. In other words, if the input causes the relay to go on, a user may turn the relay off from the web browser, even if the input is still on.

-no local relay control- The input has no effect on the local relay.

-set relay equal input- When a voltage is applied to the input, the relay goes *on*. When a voltage is removed from the input, the relay goes *off*.

-set relay equal input (init at powerup)- When a voltage is applied to the input, the relay goes *on*. When a voltage is removed from the input, the relay goes *off*. In addition, the relay will automatically be set to match the state of the input when WebRelay™ is powered on.

-set relay opposite of input- When a voltage is applied to the input, the relay goes *off*. When a voltage is removed from the input, the relay goes *on*.

-set relay opposite of input (init at powerup)- When a voltage is applied to the input, the relay goes *off*. When a voltage is removed from the input, the relay goes *on*. In addition, the relay will automatically be set to the opposite of the state of the input when WebRelay™ is powered on.

-latch relay when input on (reset via web)- When a voltage is applied to the input, the relay goes *on*. Once the relay is on it will stay *on* (unaffected by input changed) until it is turned *off* via the web by a user or WebRelay™ is powered off. This option is useful for alarming functions.

-latch relay when input off (reset via web)- When a voltage is removed from the input, the relay goes *on*. Once the relay is *on* it will stay *on* (unaffected by input changed) until it is turned off via the web by a user or WebRelay™ is powered off. This option is useful for alarming functions.

-latch relay when input changes (reset via web)- When a voltage is applied to the input or removed from the input, the relay goes *on*. Once the relay is *on* it will stay *on* (unaffected by input changes) until it is turned off via the web by a user or WebRelay™ is powered off. This option is useful for alarming functions.

-toggle relay when input on- When a voltage is applied to the input, the relay will change states. When a voltage is removed from the input, the relay will remain in its current state.

-toggle relay when input off- When a voltage is removed from the input, the relay will change states. When a voltage is applied to the input, the relay will remain in its current state.

-toggle relay when input changes- When a voltage is applied to the input or removed from the input the relay will change states.

-pulse relay when input on- When a voltage is applied to the input, the relay will pulse for the Pulse Duration specified. The voltage may remain on or be removed and the pulse time will not be affected. If the voltage is applied, removed, and then re-applied before the end of the pulse time, the Pulse Duration timer will be re-started (it will re-start each time a voltage is applied) and the relay will continue to remain *on* until the timer expires.

-pulse relay when input off- When a voltage is removed from the input, the relay will pulse for the Pulse Duration specified. The voltage may remain off or be re-applied and the pulse time will not be affected. If the voltage is removed, re-applied, and then removed again before the end of the pulse time, the Pulse Duration timer will be re-started (it will re-start each time a voltage is removed) and the relay will continue to remain *on* until the timer expires.

-pulse relay when input changes- When a voltage is applied to or removed from the input, the relay

will pulse for the Pulse Duration specified. If the state of the voltage changes before the end of the pulse, the timer will be re-started (it will re-start each time the voltage changes) and the relay will continue to remain *on* until the timer expires.

The following parameters (4-13) are available only when WebRelay™ is set to **Automatic Reboot** relay mode.

4. Ping IP Address:

This is the IP address that WebRelay™ will ping. This is typically the IP address of the device that will be re-booted upon failure (such as a server, router, computer, etc.). It could however, be the address of a device on the opposite side of a communications link. This is useful to auto reboot a CSU/DSU, satellite modem, router, etc..

The screenshot shows the WebRelay™ Setup page in Mozilla Firefox. The browser address bar shows the URL `http://192.168.1.6/setup.html`. The page title is "Setup" and the logo "WEBRelay™" is visible. The "Relay/Input" tab is selected, showing the following configuration options:

- Relay Mode: Standard Automatic Reboot
- Ping IP Address: 192 . 168 . 1 . 15
- Successful Ping Period: 60 secs
- Unsuccessful Ping Period: 10 secs
- Delay Before First Ping After Reboot: 120 secs
- Reboot Timer 1 (T1): 10 secs
- Reboot Timer 2 (T2): 5 secs
- Reboot Timer 3 (T3): 2 secs
- Reboot Options: pulse off T1 secs
- Failed Pings Before Reboot: 5
- Max Reboot Attempts: 10
- Remote Relay Options: no remote relay control
- Remote Relay IP Address: 192 . 168 . 1 . 3
- Remote TCP Port: 80
- Relay #: 0
- Password: *****
- Keep Alive: YES(No TX State)

At the bottom of the form are "Submit" and "Reset" buttons. The browser status bar at the bottom shows "Done".

5. Successful Ping Period:

This is the time interval (in seconds) between successful ping requests. This time can be set from 1 to 60000 seconds (1000 minutes or 16.666 hours).

6. Unsuccessful Ping Period:

When ping requests fail (no response from device), it may be desirable to begin pinging at a shorter time interval. This allows WebRelay™ to determine in less time that the device is not functioning. After each unsuccessful ping, WebRelay™ will wait this time interval (in seconds) before the next ping attempt. This time can be set from 1 to 60000 seconds (1000 minutes or 16.666 hours).

7. Delay Before First Ping After Reboot:

When WebRelay™ is first powered, it will wait this time interval (in seconds) before beginning to ping the device. This time delay allows the device to boot before being pinged. This time can be set from 0 to 60000 seconds (1000 minutes or 16.666 hours).

8. Reboot Timer 1 (T1):

Pulse Time 1 (in seconds). See “Reboot Options” below for details. This time can be set from 1 to 60000 seconds (1000 minutes or 16.666 hours).

9. Reboot Timer 2 (T2):

Pulse Time 2 (in seconds). See “Reboot Options” below for details. This time can be set from 1 to 60000 seconds (1000 minutes or 16.666 hours).

10. Reboot Timer 3 (T3):

Pulse Time 3 (in seconds). See “Reboot Options” below for details. This time can be set from 1 to 60000 seconds (1000 minutes or 16.666 hours).

11. Reboot Options:

This parameter defines how the device will be re-booted. This is determined by the way WebRelay™ is connected to the device. There are several options for connection. Three reboot methods are discussed here which will help with understanding of how reboot options should be set.

Reboot Method #1: Connect WebRelay™ in series with the power source of the device. By doing this, WebRelay™ can switch the device on and off by switching the power to the device on and off.

Reboot Method #2: Connect WebRelay™ in parallel with the reset switch of the device. With this approach, WebRelay™ re-boots the device by momentarily closing the reset switch. This has the advantage of being less “hard” on the device that is being controlled than switching the power on and off.

Reboot Method #3: Some devices have on/off switches that will remain in the on or off position and other devices have momentary power buttons. Devices with momentary power buttons usually will not turn on after power is applied until a user presses the power button. In this case, simply controlling the power to the device will not work for reboot because once the device is off, it will not come back on until the power button is pressed (even after power is restored, pressing the button is required). WebRelay™ can be wired in parallel with the power button and can momentarily close the power button to turn the device on or off.

With the above reboot methods explained, each option in the Reboot Options drop-down list will be discussed.

-pulse off T1 secs- This option is usually used for method #1 described above. In this case the power to the device is wired in series with the relay. Common and Normally Open contacts should be used. When this option is selected, WebRelay™ will automatically turn *on* the relay when it is first powered. The Normally Open relay contacts will be closed and the device is powered on. When the device needs to be re-booted, the relay contacts will

be pulsed *off* for the time duration specified in T1 (see above) seconds. This option does not use parameters T2 or T3.

-pulse on T1 secs- This option is usually used for method #2 described above. In this case the reset button is wired in parallel with the relay. Common and Normally Open contacts are used. When the device needs to be re-booted, the relay will be pulsed *on* for the time duration specified in T1 (see above) seconds. This option does not use parameters T2 or T3.

-pulse on T1 secs, off T2 secs, on T3 secs (without pp)- This option is usually used for method #3 described above. In this case the power button is wired in parallel with the relay. Common and Normally Open contacts are used. When the device needs to be re-booted, the relay will be pulsed *on* for T1 (see above) seconds. After the first pulse, the relay will stay *off* for T2 seconds, and then pulse *on* for T3 seconds. The purpose for the first pulse (T1) is to turn the device off. Usually this requires holding the power switch for 5-10 seconds. Once the device is off, there is a delay before turning the device back on. This delay time is specified in parameter T2. Finally the device is turned on once again by applying a second pulse (T3) to the power switch. The second pulse usually does not need to be as long as the first. The notation ***without pp*** means without power-up pulse. The power-up pulse is explained in the next paragraph.

-pulse on T1 secs, off T2 secs, on T3 secs (with pp)- This option is identical to the option above, but with one exception; it pulses at power-up (***with pp***). If WebRelay™ loses power, it is assumed that the device which WebRelay™ controls has also lost power. When the power is restored, the device will not come back on without some help. When this reboot option is selected, WebRelay™ will automatically power the device on each time power is lost and restored. It does this by waiting T2 seconds after power-up and then pulsing T3 seconds. After the pulse to turn the device on, WebRelay™ will allow the device to boot and begin its normal ping algorithm.

12. Failed Pings Before Reboot:

The device will be re-booted after this number of ping failures. This number can be set between 1 and 255.

13. Max Reboot Attempts:

After the device has been re-booted this number of times without any successful pings, it is assumed that there are problems with the device and WebRelay™ will no longer attempt to re-boot the device. At this point, WebRelay™ will leave the device on but will disable the auto re-boot feature. The auto re-boot feature will remain disabled until a user enables it through the control page or WebRelay™ is powered down and powered up once again. This number can be set between 1 and 255.

The following parameters (14-19) are available when WebRelay™ is set to either ***Standard*** or ***Automatic Reboot*** relay mode.

14. Remote Relay Options:

The optically-isolated input can be configured to control a WebRelay™ device at a remote location. The 'Remote Relay Options' setting is used to specify if and how the input affects the remote relay. The options in the drop down list are described below. Note that in all cases, input changes will only affect the remote relay at the time the input is changed. Once the change has taken place the state of the input has no effect on the state of the remote relay. In other words, if the input causes the remote relay to go on, a user may turn the remote relay off from the web browser, even if the local input is still on.

-no remote relay control- The input has no effect on the remote relay.

-remote command equals input- When a voltage is applied to the input, a command is sent to the

- remote WebRelay™ to set the relay state to *on*. When a voltage is removed from the input, a command is sent to the remote WebRelay™ to set the relay state to *off*.
- remote command opposite of input**- When a voltage is applied to the input, a command is sent to the remote WebRelay™ to set the relay state to *off*. When a voltage is removed from the input, a command is sent to the remote WebRelay™ to set the relay state to *on*.
 - send on command when input on (no off command)**- When a voltage is applied to the input, a command is sent to the remote WebRelay™ to set the relay state to *on*. When a voltage is removed from the input, no commands are sent to the remote WebRelay™.
 - send on command when input off (no off command)**- When a voltage is removed from the input, a command is sent to the remote WebRelay™ to set the relay state to *on*. When a voltage is applied to the input, no commands are sent to the remote WebRelay™.
 - send off command when input off (no on command)**- When a voltage is removed from the input, a command is sent to the remote WebRelay™ to set the relay state to *off*. When a voltage is applied to the input, no commands are sent to the remote WebRelay™.
 - send off command when input on (no on command)**- When a voltage is applied to the input, a command is sent to the remote WebRelay™ to set the relay state to *off*. When a voltage is removed from the input, no commands are sent to the remote WebRelay™.
 - send pulse command when input on**- When a voltage is applied to the input, a command is sent to the remote WebRelay™ to pulse the relay. When a voltage is removed from the input, no commands are sent.
 - send pulse command when input off**- When a voltage is removed the input, a command is sent to the remote WebRelay™ to pulse the relay. When a voltage is applied to the input, no commands are sent.
 - send pulse command when input changes**- When a voltage is applied to the input or removed from the input, a command is sent to the remote WebRelay™ to pulse the relay.

15. Remote Relay IP Address:

When any option in the 'Remote Relay Options' setting is selected other than ***no remote relay control***, commands are sent over the IP network to this address as the control voltage input changes.

16. Remote TCP Port:

When any option in the 'Remote Relay Options' setting is selected other than ***no remote relay control***, commands are sent over the IP network to this TCP port on the remote WebRelay™ as the control voltage input changes.

17. Relay #:

When any option in the 'Remote Relay Options' setting is selected other than ***no remote relay control***, commands are sent to the remote device with this relay offset. This option should ALWAYS be set to 0, unless the remote device is something other than WebRelay™. This is used, for example, when the remote device has multiple relays. For example, the WebRelay Quad board has 4 relays. To send commands to third relay on the WebRelay Quad board, this option would be set to 3. To send commands to the first relay on the Quad board, this option would be set to 1.

For a more technical description of this option, commands sent to remote WebRelay™ units look like this...

`http://192.168.1.2/state.xml?relayState=1`

When a 0 is entered into this field, the above format is used which is required for standard WebRelay™ units.

Commands sent to a remote WebRelay Quad board look like this...

`http://192.168.1.2/state.xml?relay1State=1`

`http://192.168.1.2/state.xml?relay2State=1`

...

`http://192.168.1.2/state.xml?relay4State=1`

In this case, each of the four relays can be addressed as illustrated. The address of the specific relay

on the WebRelay quad board is given in this field.

For custom computer applications, the ‘Relay #’ option may be useful to monitoring input changes as they happen. This would work by pointing the ‘Remote Relay IP Address’ above, to a computer instead of another WebRelay™ device. Each time the input changes, a “command” would be sent to the computer indicating the change. The computer could identify the device sending the command by the ‘Relay #’.

This field may be set from 0 to 255.

18. Password:

When any option in the ‘Remote Relay Options’ setting is selected other than ***no remote relay control***, this password is included with commands that are sent to the remote WebRelay™ unit. If the remote WebRelay™ unit has the control password option enabled, the password for that unit must be entered here for the remote commands to have any effect.

19. Keep Alive:

When any option in the ‘Remote Relay Options’ setting is selected other than ***no remote relay control***, the Keep Alive option may be turned on to keep the TCP connection to the remote WebRelay™ unit alive. If the connection is alive, commands sent to the remote unit will change the state of the remote relay almost instantly (with a good network connection). If the connection is not alive, commands sent to the remote unit will be delayed a few seconds while the connection is being setup. There are three options available in this field.

I. ***NO***: When this option is selected, the TCP connection between the two units will be terminated after each command is sent. Each time a command must be sent, the two WebRelay™ units will re-establish a connection and the command will be sent to the remote unit. This means that when the input voltage toggles, it may take a few seconds for the remote relay to respond. In many cases, this delay may not be a problem. This option uses the least network bandwidth (and is the most secure) because communications only take place when the input voltage changes.

II. ***YES(No TX State)***: When this option is selected, a message is sent to the remote unit every 50 seconds to keep the TCP connection alive. The message does not contain the state of the local input. If power is lost and the control voltage changes while the unit is not powered, the new control voltage status will not be sent to the remote unit when the power is restored. The state will not be updated until the next time the control input changes.

III. ***YES(TX State)***: When this option is selected, a message is sent to the remote unit every 50 seconds to keep the TCP connection alive. This message will contain the current state of the input. By sending the state of the unit, changes to the control voltage input will eventually be sent to the remote unit, even if the change occurred during a power loss. Transmit state is only valid for the ‘Remote Relay Options’ ***remote command equals input*** and ***remote command opposite of input***. If any of the other ‘Remote Relay Options’ are selected, the state will not be transmitted.

Note that when units are set up to require a control password, this password must be sent each time the state is updated. When the option is selected to transmit the state of the input each time the keep alive message is sent, the password will be frequently transmitted over the network. This may not be a problem, but the user should be aware that the more often the password is sent, the more opportunity hackers would have to capture the password, decode it, and potentially use it to control the remote relay (especially in public networks such as the Internet).

2.4.5 Control Page Setup (When Relay Mode is set to Standard)

Once WebRelay™ is set up, it can be controlled and monitored using a web browser by accessing its control page. Titles, colors, and basic contents of the control page can be customized by setting the appropriate options on the 'Control Page Setup' page. Note that this setup page only affects the control web page and does not affect the function of WebRelay™ in any way. This section describes the 'Control Page Setup' page when the relay mode is set to *standard*. The next section will describe the setup page for *automatic reboot mode*.

1. Main Header Text:

This text will be displayed in the main header area of the control page. This field can be up to 25 characters in length.

The screenshot shows the 'Control Page Setup' configuration page for WebRelay. The page is displayed in Microsoft Internet Explorer at the address http://192.168.1.2/setup.html. The page has a blue header with the WebRelay logo and the title 'Setup'. Below the header are five tabs: Network, Password, Relay/Input, Control Page Setup (selected), and Relay Control Page. The main content area is titled 'Control Page Setup:' and contains the following configuration options:

- Main Header Text:** WebRelay
- Relay Description:** Relay Description
- Display Relay Status:** Yes (selected) No
- Status ON Color:** Gr (selected) Rd
- Status ON Text:** Relay ON
- Status OFF Color:** Gr Rd (selected)
- Status OFF Text:** Relay OFF
- ON/OFF Buttons:** 0 1 (selected) 2
- Button1 Label:** ON OFF
- Button2 Label:** TURN OFF
- Pulse Button:** Yes (selected) No
- Pulse Button Label:** Pulse
- Display Input Status:** Yes (selected) No
- Input Description:** Input Description
- Input ON Color:** Gr (selected) Rd
- Input ON Text:** Input ON
- Input OFF Color:** Gr Rd (selected)
- Input OFF Text:** Input OFF
- Auto Refresh Page:** Yes (selected) No
- Duration:** 3 sec

At the bottom of the form are two buttons: 'Submit' and 'Reset'.

2. Relay Description:

This text is used to describe the function of the relay on the control page. This text will not appear if the 'Display Relay Status' is set to *No*, the 'On/Off Buttons' is set to *0*, and the 'Pulse Button' is set to *No*. This field can be up to 20 characters in length.

3. Display Relay Status:

When this option is set to *Yes*, the relay status will be displayed on the control page. If it is set to *No*, the relay status will not be displayed.

4. Status ON Color:

When the 'Display Relay Status' option is set to *Yes*, this field specifies the color that will be displayed when the relay is *on* (coil energized).

5. Status ON Text:

When the 'Display Relay Status' option is set to *Yes*, this field specifies the text that will be displayed when the relay is *on* (coil energized).

6. Status OFF Color:

When the 'Display Relay Status' option is set to *Yes*, this field specifies the color that will be displayed when the relay is *off* (coil not energized).

7. Status OFF Text:

When the 'Display Relay Status' option is set to *Yes*, this field specifies the text that will be displayed when the relay is *off* (coil not energized).

8. ON/OFF Buttons:

This option allows the user to specify *0*, *1*, or *2* buttons to turn the relay on or off. *Zero* buttons disables the users ability to turn the relay *on* and *off* (a pulse button may still be included... see below). *One* button may be used to toggle the relay *on* and *off*. *Two* buttons gives the user one button to turn the relay *on* and another button to turn the relay *off*.

9. Button 1 Label:

When *1* or *2* buttons is selected in the 'ON/OFF Buttons' option, this field specifies the text that will be displayed in pushbutton number 1.

10. Button 2 Label:

When *2* buttons is selected in the 'ON/OFF Buttons' option, this field specifies the text that will be displayed in pushbutton number 2.

11. Pulse Button:

This option allows the user to include a pulse button to control the relay. If the pulse button is included, the relay will *pulse* for the time specified in the 'Pulse Duration' field in the 'Relay/Input' page each time the button is pressed.

12. Pulse Button Label:

When the 'Pulse Button' option is set to *Yes*, the text entered here will appear in the pulse button on the control page.

13. Display Input Status:

When this option is set to *Yes* the status of the optically-isolated input will be displayed on the control page. Note that this input can be used to control a local relay, a remote relay, or be read using the XML page no matter how this option is set.

14. Input Description:

This is the text that will be displayed next to the input status when the 'Display Input Status' is enabled. It can be up to 20 characters in length.

15. Input ON Color:

When 'Display Input Status' is set to **Yes**, this field specifies the color that will be displayed when the input is *on* (voltage applied to input).

16. Input ON Text:

When 'Display Input Status' is set to **Yes**, this field specifies the text that will be displayed when the input is *on* (voltage applied to input).

17. Input OFF Color:

When 'Display Input Status' is set to **Yes**, this field specifies the color that will be displayed when the input is *off* (voltage is not applied to input).

18. Input OFF Text:

When 'Display Input Status' is set to **Yes**, this field specifies the text that will be displayed the input is *off* (voltage is not applied to input).

19. Auto Refresh Page:

Web pages traditionally display static information. The WebRelay™ control page, however, displays information that is dynamic. Each time the control page is loaded to the browser, it displays a snapshot of the current status of the unit. If the state of the unit changes, the information on the control page will be outdated unless the page is re-loaded. Whenever a user changes the state of the relay via the web browser, the web page will automatically reload the control page to display current information. If, however, the relay state changes due to a change in the control voltage input or due to a command sent from another machine, the relay state will not be updated and the control page information will be obsolete. In addition, when the optically-isolated input changes, the control page will be obsolete until the page is refreshed. WebRelay™ can not force the web page to be updated when the input changes. The 'Auto Refresh Page' option will cause the control page to continually update its contents by setting a timer in the web page that causes it to be reloaded at a specified time interval.

20. Duration:

If the 'Auto Refresh Page' option is set to **Yes**, this field specifies the time interval in seconds that the page will be refreshed. It can be set from 1 to 32 seconds.

2.4.6 Control Page Setup (When Relay Mode is set to Automatic Reboot)

Once WebRelay™ is set up, it can be controlled and monitored using a web browser by accessing its control page. Titles, colors, and basic contents of the control page can be customized by setting the appropriate options on the 'Control Page Setup' page. Note that this setup page only affects the control web page and does not affect the function of WebRelay™ in any way. This section describes the 'Control Page Setup' page when the relay mode is set to **Auto Reboot**.

1. Main Header Text:

This text will be displayed in the main header area of the control page. This field can be up to 25 characters in length.

2. Relay Description:

This text is used to describe the function of the relay on the control page. This text will not appear if the 'Display Relay Status' is set to **No**, and 'ON/OFF' buttons are not displayed which allow relay control. This field can be up to 20 characters in length.

Note: The following settings (3-7) are used to set up the way the relay status is displayed. Please be aware that when WebRelay™ is used for re-boot purposes, the relay status may or may not be the same as the device status. When WebRelay™ is used to assert the a reset signal on the motherboard of a server, for example, the relay will be 'OFF' most of the time even though the server is 'ON' most of the time. The specific re-boot method used should be considered when assigning text and color to the relay status.

3. Display Relay Status:

When this option is set to **Yes**, the relay status will be displayed on the control page. If it is set to **No**, the relay status will not be displayed.

4. Status ON Color:

When the 'Display Relay Status' option is set to **Yes**, this field specifies the color that will be displayed when the relay is *on* (coil energized).

http://192.168.1.2/setup.html - Microsoft Internet Explorer

File Edit View Favorites Tools Help

Back Forward Stop Home Search Favorites Refresh Print Mail News RSS Feeds

Address http://192.168.1.2/setup.html Go Links >>

WEBRelay™ Setup

Network Password Relay/Input Control Page Setup Relay Control Page

Control Page Setup:

Main Header Text: WebRelay

Relay Description: Relay Description

Display Relay Status: Yes No

Status ON Color: Gr Rd

Status ON Text: Relay ON

Status OFF Color: Gr Rd

Status OFF Text: Relay OFF

Display Input Status: Yes No

Input Description: Input Description

Input ON Color: Gr Rd

Input ON Text: Input ON

Input OFF Color: Gr Rd

Input OFF Text: Input OFF

ON/OFF Buttons: Yes No

Reboot Button: Yes No

Auto Refresh Page: Yes No

Duration: 3 sec

Submit Reset

5. Status ON Text:

When the 'Display Relay Status' option is set to **Yes**, this field specifies the text that will be displayed when the relay is *on* (coil energized).

6. Status OFF Color:

When the 'Display Relay Status' option is set to **Yes**, this field specifies the color that will be displayed when the relay is *off* (coil not energized).

7. Status OFF Text:

When the 'Display Relay Status' option is set to **Yes**, this field specifies the text that will be displayed when the relay is *off* (coil not energized).

8. Display Input Status:

When this option is set to **Yes** the status of the optically-isolated input will be displayed on the control page. For most reboot applications, the optically-isolated input will not be used so this should be set to **No**. Note that this input can be used to control a remote relay or be read using the XML page no matter how this option is set (local relay control is not available in **Automatic Reboot** mode).

9. Input Description:

This is the text that will be displayed next to the input status when the 'Display Input Status' is enabled. This field can be up to 20 characters in length.

10. Input ON Color:

When 'Display Input Status' is set to **Yes**, this field specifies the color that will be displayed when the input is *on* (voltage applied to input).

11. Input ON Text:

When 'Display Input Status' is set to **Yes**, this field specifies the text that will be displayed when the input is *on* (voltage applied to input).

12. Input OFF Color:

When 'Display Input Status' is set to **Yes**, this field specifies the color that will be displayed when the input is *off* (voltage is not applied to input).

13. Input OFF Text:

When 'Display Input Status' is set to **Yes**, this field specifies the text that will be displayed the input is *off* (voltage is not applied to input).

14. ON/OFF Buttons:

When this option is set to **Yes**, the control page will display buttons to turn the device *on* and *off*. These buttons attempt to represent the state of the device and not the relay (the relay status however, represents the state of the relay).

When the 'Reboot Options' field (under the 'Relay/Input' tab) is set to **pulse off T1 secs**, it is assumed that the device is *on* when the relay is *on*. In this case the 'on' button will turn both the relay and the device *on* and the 'off' button will turn both the relay and the device *off*.

When the 'Reboot Options' field (under the 'Relay/Input' tab) is set to **pulse on T1 secs**, it is assumed that the device is *on* when the relay is *off*. In this case the 'on' button will turn the relay *off* and the device *on*. The 'off' button will turn the relay *on* and the device *off*.

When the 'Reboot Options' field (under the 'Relay/Input' tab) is set to either **pulse on T1 secs, off T2 secs (without pp)**, or **pulse on T1 secs, off T2 secs (with pp)**, the 'ON/OFF' buttons will not be displayed in the control page. In addition, the option to display the ON/OFF buttons will not appear in the 'Control Page Setup' page.

It is recommended that the 'ON/OFF' buttons not be displayed on the control page in two distinct cases. First, if turning the device *off* causes communications with WebRelay™ to be lost (for example WebRelay™ controls a router or modem which must be operating properly to remotely communicate with WebRelay™). In this case the user may press the 'OFF' button and lose communications with WebRelay™ so he/she cannot turn the device back *on*. The second situation where not displaying the 'ON/OFF' buttons is recommended is when WebRelay™ is wired to control a reset line instead of power. In this case the user cannot actually power off the device so 'ON/OFF' buttons are not necessary.

15. Reboot Button:

When this option is set to **Yes**, the control page will display a button to reboot the device. When the user presses this button, WebRelay™ will go through the reboot sequence specified in the 'Reboot Options' field (under the 'Relay/Input' tab).

16. Auto Refresh Page:

Web pages traditionally display static information. The WebRelay™ control page, however, displays information that is dynamic. Each time the control page is loaded to the browser, it displays a snapshot of the current status of the unit. If the state of the unit changes, the information on the control page will be outdated unless the page is re-loaded. Whenever a user changes the state of the relay via the web browser, the web page will automatically reload the control page to display current information. If, however, the relay state changes due to a change in the control voltage input or due to a command sent from another machine, the relay state will not be updated and the control page information will be obsolete. In addition, when the optically-isolated input changes, the control page will be obsolete until the page is refreshed. WebRelay™ can not force the web page to be updated when the input changes. The 'Auto Refresh Page' option will cause the control page to continually update its contents by setting a timer in the web page that causes it to be reloaded at a specified time interval.

17. Duration:

If the 'Auto Refresh Page' option is set to **Yes**, this field specifies the time interval in seconds that the page will be refreshed. It can be set from 1 to 32 seconds.

Section 3: Operation

WebRelay™ can be operated by applying a voltage to the optically-isolated input, using a web browser, or by sending text commands to an XML status/control page. Using a control voltage was described throughout previous sections and will not be described here.

3.1 Browser Operation (Standard Relay Mode)

Once the unit is set up, the control page may be accessed by typing the following URL into the web browser:

<http://192.168.1.2> (Note that if the IP address was changed, replace the default IP address shown with the new address that was assigned. Note also that if any port is used other than port 80, the port must also be included in the request: <http://192.168.1.2:8000>) The new control page will appear. A control page with default settings is shown below.



3.2 Browser Operation (Automatic Reboot Relay Mode)

The control page for automatic reboot mode is accessed the same as it is in standard mode. See section 3.1 for information on accessing the control page.









Using the Automatic Reboot control page is simple and straightforward. Control pages will vary based upon options selected in setup. An example control page is shown below. A basic description of the control page follows.

Input Description and Input State: The state of the optically-isolated input can be displayed on this control page. This may be useful to monitor the electrical state of a device. Most reboot applications will not use the optically-isolated input so it can be disabled in the setup so that it is not displayed.

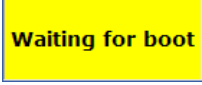
Relay Description and Relay State - A brief user description of the relay (or device being controlled) and the relay state may be displayed on the control page. Note that the relay state represents the current state of the relay and may or may not represent the state of the device being controlled. This is due to the fact that there are multiple reboot configurations that function differently. It is recommended that in WebRelay™ setup, appropriate text, state colors, and state labels be used that best represent the device being controlled.

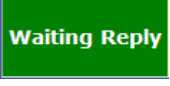
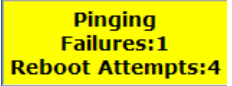
ON/OFF Buttons - These buttons are available only when single pulse reboot options are selected in the 'Relay/Input' setup and the 'On/Off Buttons' field in the 'Control Page Setup' is set to *Yes*. When WebRelay™ is wired to correctly match the reboot logic, these buttons will turn the device on and off.

Reboot State - This field provides important information about the current status of the automatic reboot controller. Each state is described below.

Reboot State	Description
	After power-up, WebRelay™ will wait for the device to boot before sending any ping requests. The “Waiting for boot” message is displayed during this wait time. The wait time is specified in the ‘Delay Before First Ping After Reboot’ parameter under the ‘Relay/Input’ tab.
	WebRelay™ is periodically pinging device. This indicates normal operation.
	This indicates that a ping request has been sent out and WebRelay™ is waiting for a reply from the device. Usually under normal circumstances the device will reply very quickly and there will be no time to display this message.
	The status field looks like this when one or more ping requests have failed. The top line indicates the current state. It may be ‘Pinging’, ‘Waiting Reply’, ‘Waiting for boot’, or in its ‘Reboot Sequence’. The next line (Failures) indicates the number of consecutive ping request have failed to respond. This counter is reset each time WebRelay™ receives a successful ping response. The counter is also reset each time WebRelay™ re-boots the device. The bottom line (Reboot Attempts) indicates the number of consecutive times that WebRelay™ has re-booted the device. This counter is reset upon a successful ping response or when the user manually re-boots the device.
	This indicates that WebRelay™ is currently performing a reboot. This may be a single pulse or two pulses with a delay between them depending upon how WebRelay™ is configured.
	This indicates that WebRelay™ has re-booted the device the maximum number of times specified in the ‘Max Reboot Attempts’ field under the ‘Relay/Input’ tab. The device failed to respond to any ping requests, even after being re-booted (possibly numerous times). Once the maximum number of attempts have been reached, WebRelay™ will leave the device powered on and quit trying to perform reboot attempts.
	This indicates that the user has turned the auto reboot feature off. Note that the auto reboot feature will automatically be re-enabled if power is lost and restored to WebRelay™

Reboot Button:

This button may be included on the control page (as specified in the setup). When the user presses this button, WebRelay™ will begin the reboot sequence as defined in the ‘Reboot Options’.

Auto ON/OFF Button:

This allows the user to temporarily disable the automatic reboot feature. When automatic reboot is disabled, WebRelay™ will stop pinging the device. Automatic reboot will be disabled until a user re-enables it or WebRelay™ is powered cycled. The user can re-enable this feature by pressing the ‘Auto ON/OFF’ button, or by changing any of the reboot parameters in the setup pages.

3.3 XML Operation

Custom computer applications may be created to monitor and control WebRelay™ without using a web browser. Monitoring the state of the input and the relay is done by sending a request to port 80 (or port specified in setup) for the XML page. Control of the relay is done by sending GET requests to the same page on port 80 (or port specified in setup). This can be demonstrated by entering commands into the URL line of a web browser.

Request the current state: <http://192.168.1.2/state.xml>

This will return the following XML page.:

```
<?xml version="1.0" encoding="utf-8" ?>
-<datavalues>
  <relaystate>1</relaystate>
  <inputstate>0</inputstate>
  <rebootstate>0</rebootstate>
</datavalues>
```

The tags <relaystate>, <inputstate>, and <rebootstate> indicate the current state of the WebRelay™ unit. Values for each tag is described below.

<relaystate> 0=off(coil off)
 1=on (coil energized)

<inputstate> 0=off (voltage not applied to input)
 1=on (voltage applied to input)

<rebootstate> 0=Auto Reboot off
 1=Pinging
 2=Waiting for response
 3=Rebooting
 4=Waiting for boot

Commands can be sent to WebRelay™ which control the relay and change its state. Commands are sent using a variable called relayState. Two examples of using relayState are given here.

Turn the relay ‘off’: <http://192.168.1.2/state.xml?relayState=0>

Turn the relay ‘on’: <http://192.168.1.2/state.xml?relayState=1>

All relayState options are contained in the following list.

relayState 0=Turn relay off (when in *Automatic Reboot* mode, relay turns off but auto-reboot is still enabled)
 1=Turn relay on (when in *Automatic Reboot* mode, relay turns on but auto-reboot is still enabled)
 2=Pulse relay (only when relay is in *Standard* mode)
 2=Reboot (only when relay is in *Automatic Reboot* mode)
 3=Disable automatic reboot (only when relay is in *Automatic Reboot* mode)
 4=Enable automatic reboot (only when relay is in *Automatic Reboot* mode)

Note that when the above commands are sent to WebRelay™, its current state is returned in the form of an XML page. The commands can also be sent without having WebRelay™ return the XML page. This is accomplished by adding the noReply field as follows.

Turn the relay ‘on’ without returning state: <http://192.168.1.2/state.xml?relayState=1&noReply=1>

Turn the relay ‘off’ without returning state: <http://192.168.1.2/state.xml?relayState=0&noReply=1>

Password :

If the control password is enabled in the WebRelay™ unit and the XML page is requested through a browser, the browser will prompt the user for the password. If the XML request is sent from another application and not a browser, the html request will need to contain the password encoded using the base 64 encoding scheme. The html request header without the password looks like this:

```
GET /state.xml?noReply=1 HTTP/1.1 (Ends with two \r\n)
```

The html request header with the password looks like this:

```
GET /state.xml?relayState=1&noReply=1 HTTP/1.1  
Authorization: Basic bm9uZTp3ZWJyZWxheQ== (Ends with two \r\n)
```

where bm9uZTp3ZWJyZWxheQ== is the base 64 encoded version of the username and password
none:webrelay

A utility is provided at <http://www.ControlByWeb.com/encoder> that can be used to encode the password. The utility is used by simply typing the string username:password into the website and pressing encode.

Appendix A: Restoring Factory Default Settings

In the event that the IP address or passwords are forgotten, WebRelay™ may be restored to its original factory default settings. To do this, first remove the power from the unit. For non-POE (Power Over Ethernet) units, this may be accomplished by removing the unit from its socket. For POE units, simply disconnect the network line. Next, insert a thin object (such as a toothpick) through the small hole in the bottom of the unit to press the small button that is located inside the unit. When the object is inserted, a tactile feel can be detected as the button is depressed. While holding the button down, apply power and wait for about 15 seconds. After about 15 seconds, release the button. Now all settings will be back to the original factory defaults. **CAUTION: DO NOT USE METAL OBJECTS FOR THIS FUNCTION.**

Appendix B: Specifications

Power Requirements:

Power Supply Voltage: 5V ± 5%

Power Supply Current: 485mA Max

Power Over Ethernet Option: POE Class 2 (3.84 to 6.49 Watt)

I/O: 1 Optically Isolated Input, 1 Relay Output

Relay Contacts (Standard Model):

Contact Form: SPDT

Contact Material: Silver Cadmium Oxide

Max Voltage: 240VAC

Max Current: 10A (15A UL Resistive Form C derated to 10A)

Min Load: 1A @ 5VDC

Relay Contacts (LS Model):

Contact Form: SPDT

Contact Material: Ag (Au clad)

Max Voltage: 24VDC

Max Current: 1A

Min Load: 1mA @ 5VDC

Relay Control Options: ON/OFF or Pulsed

Pulse Timer Duration: 100ms to 6000 Seconds (100 minutes)

Accuracy of pulse timer: ±50ms

Optically Isolated Input:

Input Voltage: 5-12VDC

Input Current: 10-28mA

Input Functions: Monitor, Local Relay Control, Remote Relay Control

Input to Local Relay Settings: equal, invert, toggle, latch, pulse, none

Input to Remote Relay Settings: equal, invert, latch, pulse, none

Network: 10Base-T Ethernet

Network Setup: static IP address assignment, TCP port selectable

Connectors:

Power/Input/Relay: 11-pin octal

Network: 8-pin RJ-45 socket

LED Indicators: 4

-Input voltage applied

-Relay coil engaged

-Network linked

-Network activity

Physical:

Operating Temperature: 32°-158°F (0°-70°C)

Size: 1.34in (35mm) wide X 3.09in (78.4mm) high X 2.87in (73mm) deep (not including connector)
depth is 3.46in (88mm)) (including connector)

Weight (Standard): 3.8oz (108 grams)

Weight (with POE option): 4.3oz (124 grams)

Enclosure Material: Lexan 940 (main), Noryl SE1GFN2 (base)

Password Settings:

Password protection on setup page: Yes
Password protection on control page: Optional
Password Encoding: Base 64
Max password length: 10 characters

Appendix C: Open TCP Legal Notice

Portions of the software used in WebRelay™ are open source. The appropriate notices are listed below. All other parts of the software are property of Xytronix Research & Design, Inc. ©2005-2006.

Copyright (c) 2000-2002 Viola Systems Ltd.
All rights reserved.

Redistribution and use in source and binary forms, with or without modification, are permitted provided that the following conditions are met:

1. Redistributions of source code must retain the above copyright notice, this list of conditions and the following disclaimer.
2. Redistributions in binary form must reproduce the above copyright notice, this list of conditions and the following disclaimer in the documentation and/or other materials provided with the distribution.
3. The end-user documentation included with the redistribution, if any, must include the following acknowledgment:
"This product includes software developed by Viola Systems (<http://www.violasystems.com/>)."

Alternately, this acknowledgment may appear in the software itself, if and wherever such third-party acknowledgments normally appear.

4. The names "OpenTCP" and "Viola Systems" must not be used to endorse or promote products derived from this software without prior written permission. For written permission, please contact opentcp@opentcp.org.
5. Products derived from this software may not be called "OpenTCP", nor may "OpenTCP" appear in their name, without prior written permission of the Viola Systems Ltd.

THIS SOFTWARE IS PROVIDED "AS IS" AND ANY EXPRESSED OR IMPLIED WARRANTIES, INCLUDING, BUT NOT LIMITED TO, THE IMPLIED WARRANTIES OF MERCHANTABILITY AND FITNESS FOR A PARTICULAR PURPOSE ARE DISCLAIMED. IN NO EVENT SHALL VIOLA SYSTEMS LTD. OR ITS CONTRIBUTORS BE LIABLE FOR ANY DIRECT, INDIRECT, INCIDENTAL, SPECIAL, EXEMPLARY, OR CONSEQUENTIAL DAMAGES (INCLUDING, BUT NOT LIMITED TO, PROCUREMENT OF SUBSTITUTE GOODS OR SERVICES; LOSS OF USE, DATA, OR PROFITS; OR BUSINESS INTERRUPTION) HOWEVER CAUSED AND ON ANY THEORY OF LIABILITY, WHETHER IN CONTRACT, STRICT LIABILITY, OR TORT (INCLUDING NEGLIGENCE OR OTHERWISE) ARISING IN ANY WAY OUT OF THE USE OF THIS SOFTWARE, EVEN IF ADVISED OF THE POSSIBILITY OF SUCH DAMAGE.

=====

OpenTCP is the unified open source TCP/IP stack available on a series of 8/16-bit microcontrollers, please see <http://www.opentcp.org/>.

For more information on how to network-enable your devices, or how to obtain commercial technical support for OpenTCP, please see <http://www.violasystems.com/>.